

ab 03.05.2013  
from 03.05.2013  
à partir du 06.05.2013

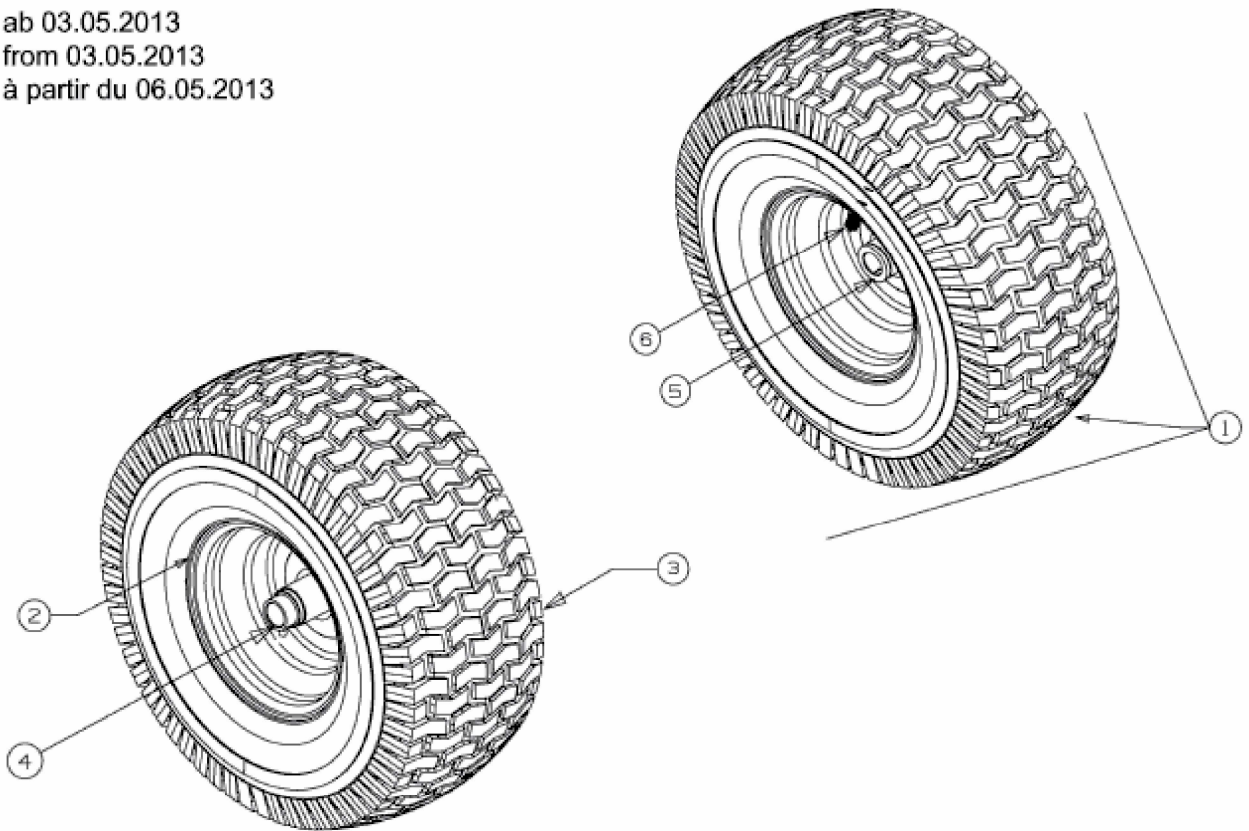

E3-02085B-04