

BL 125/92 T > 13AH771E683 (2014) > GESCHWINDIGKEITSREGELUNG

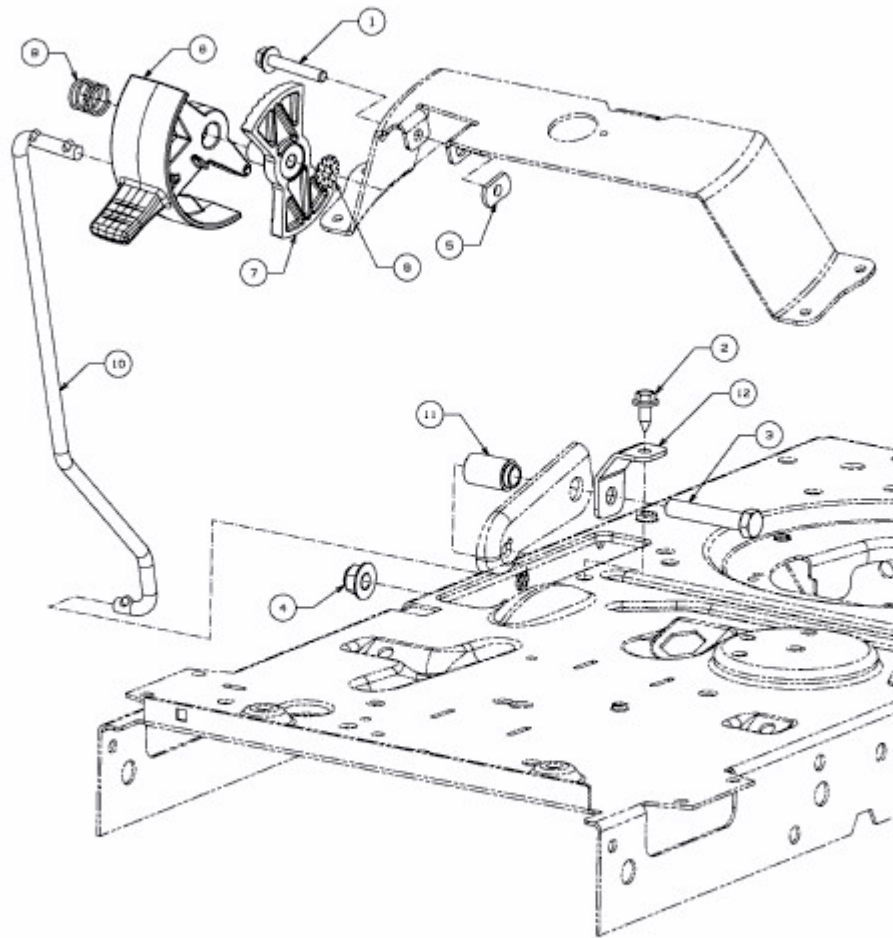

E3-07427B-01