

bis 18.01.2009
to 18.01.2009
jusqu'au 18.01.2009

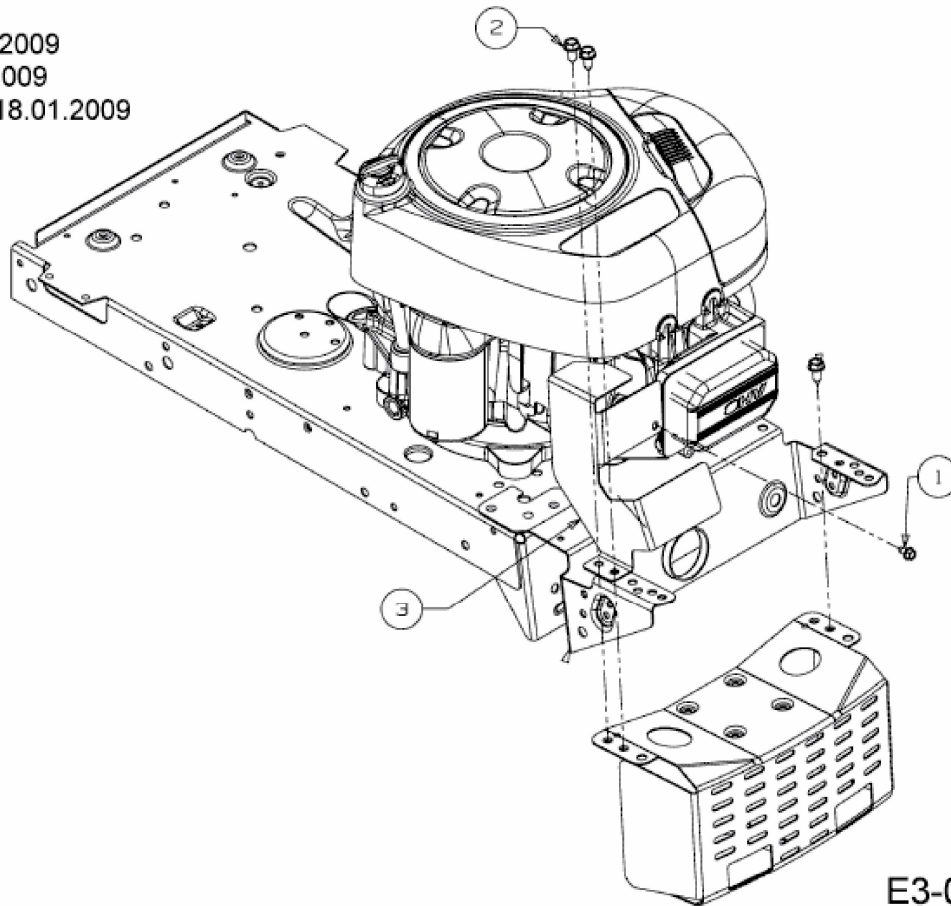

E3-03876A-02