

ab 21.04.2008
from 21.04.2008
à partir du 21.04.2008

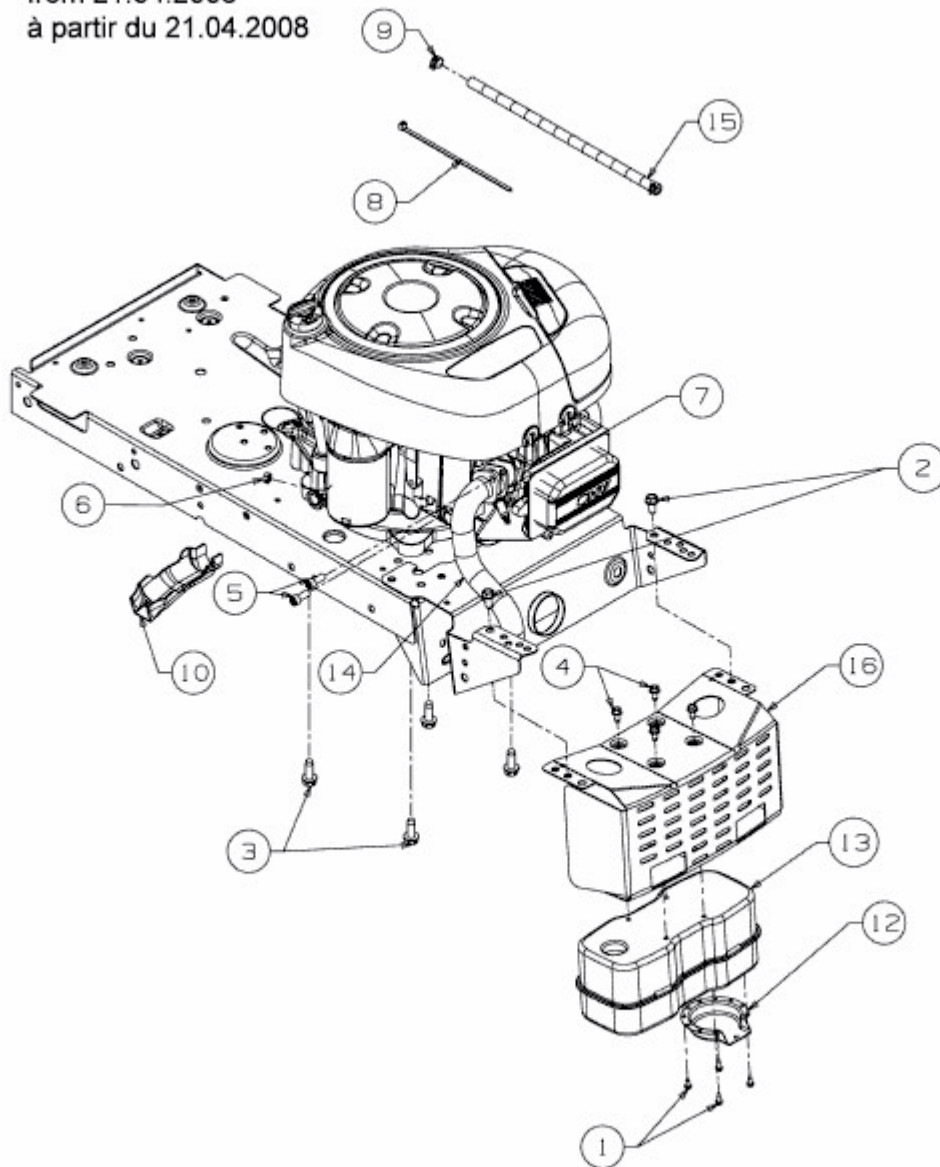

E3-02709B-01