

STORM 95/11,5 T > 13AH768F637 (2009) > GETRIEBE, VARIATOR

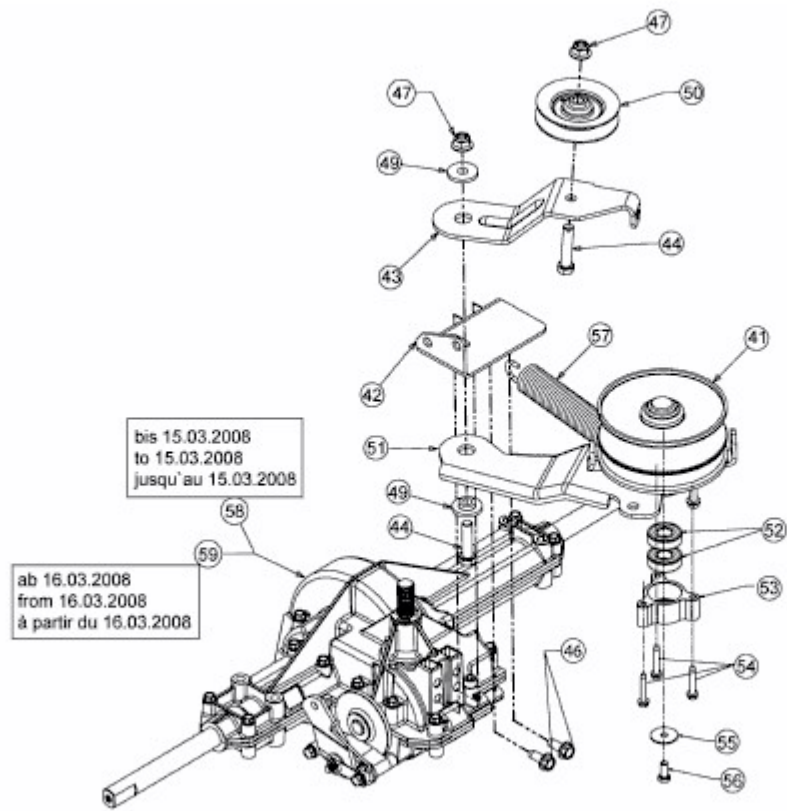

E3-02723C-02