

SMART RE 115 > 13AH765E676 (2014) > GESCHWINDIGKEITSREGELUNG

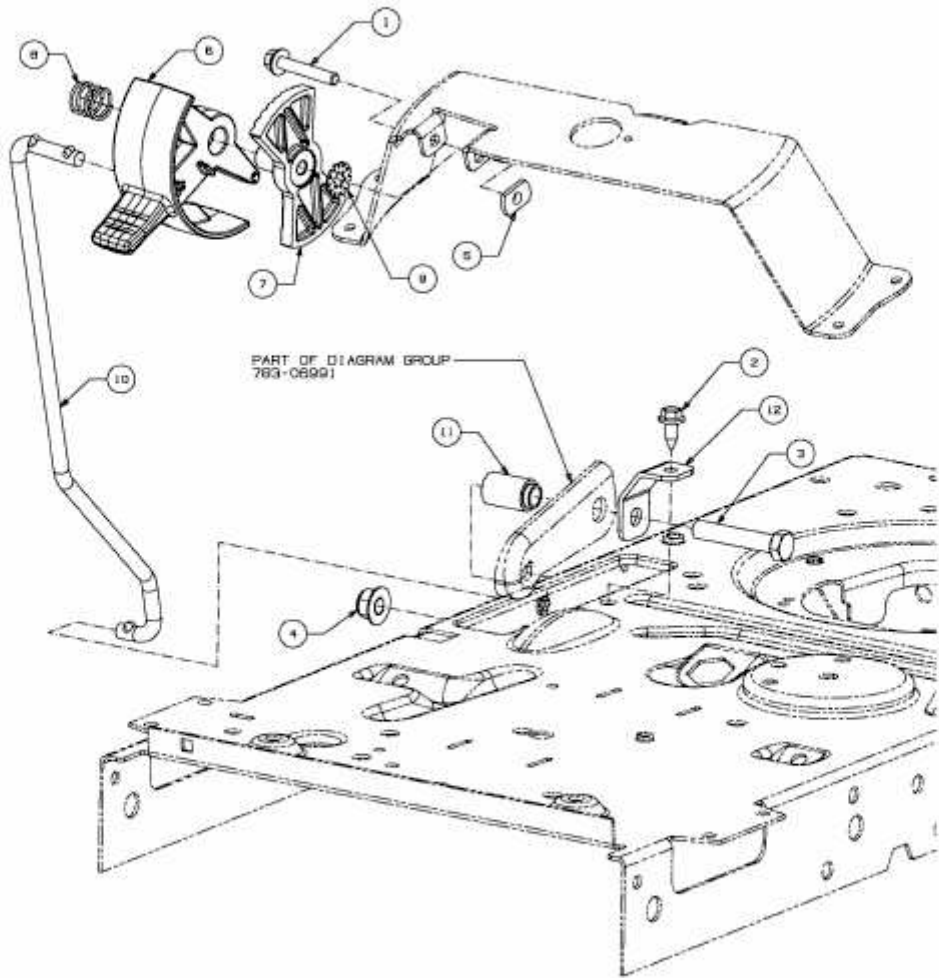

E3-07438B-01