

SMART RE 125 > 13AH765E600 (2014) > FAHRANTRIEB, PEDALE

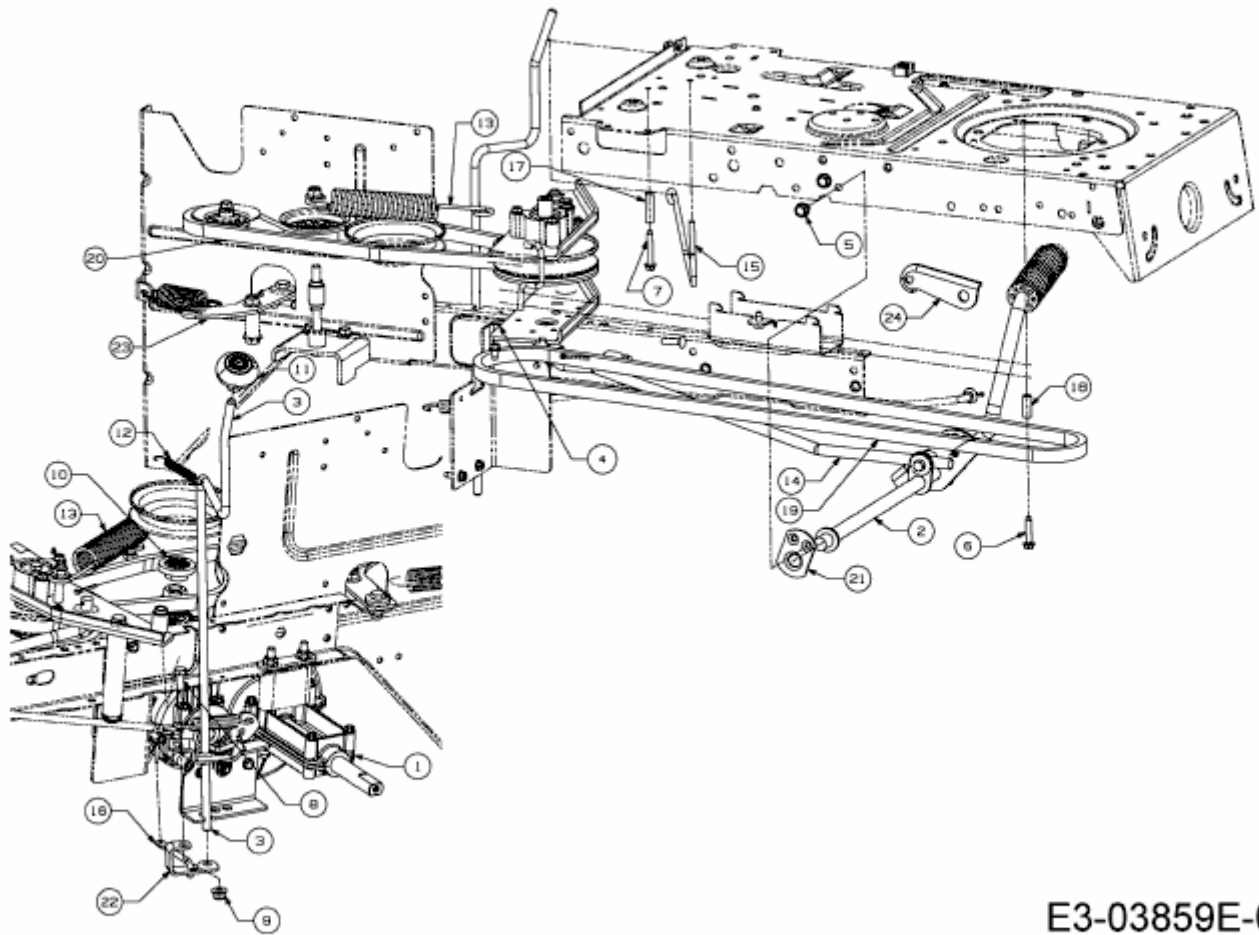

E3-03859E-01