

SMART RE 125 > 13AH765E600 (2014) > GESCHWINDIGKEITSREGELUNG

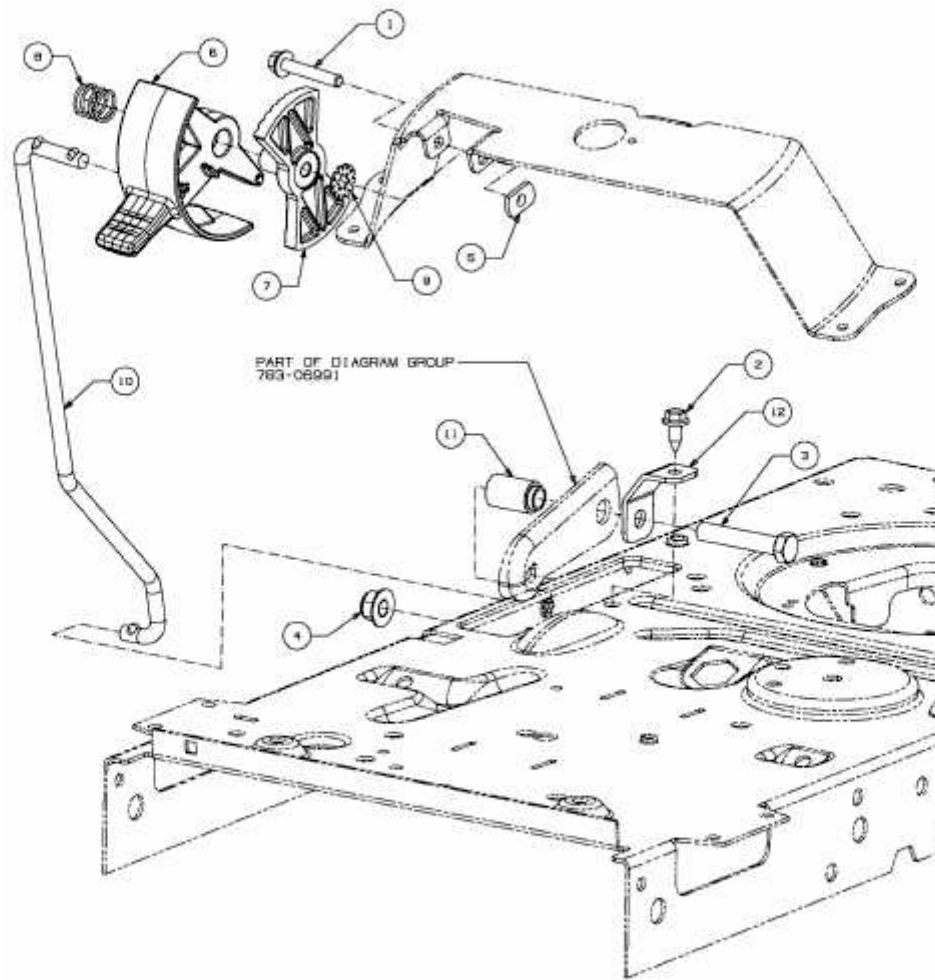

E3-07438B-01