

RS 125/96 B > 13AH762F670 (2008) > GESCHWINDIGKEITSREGELUNG, PEDALE

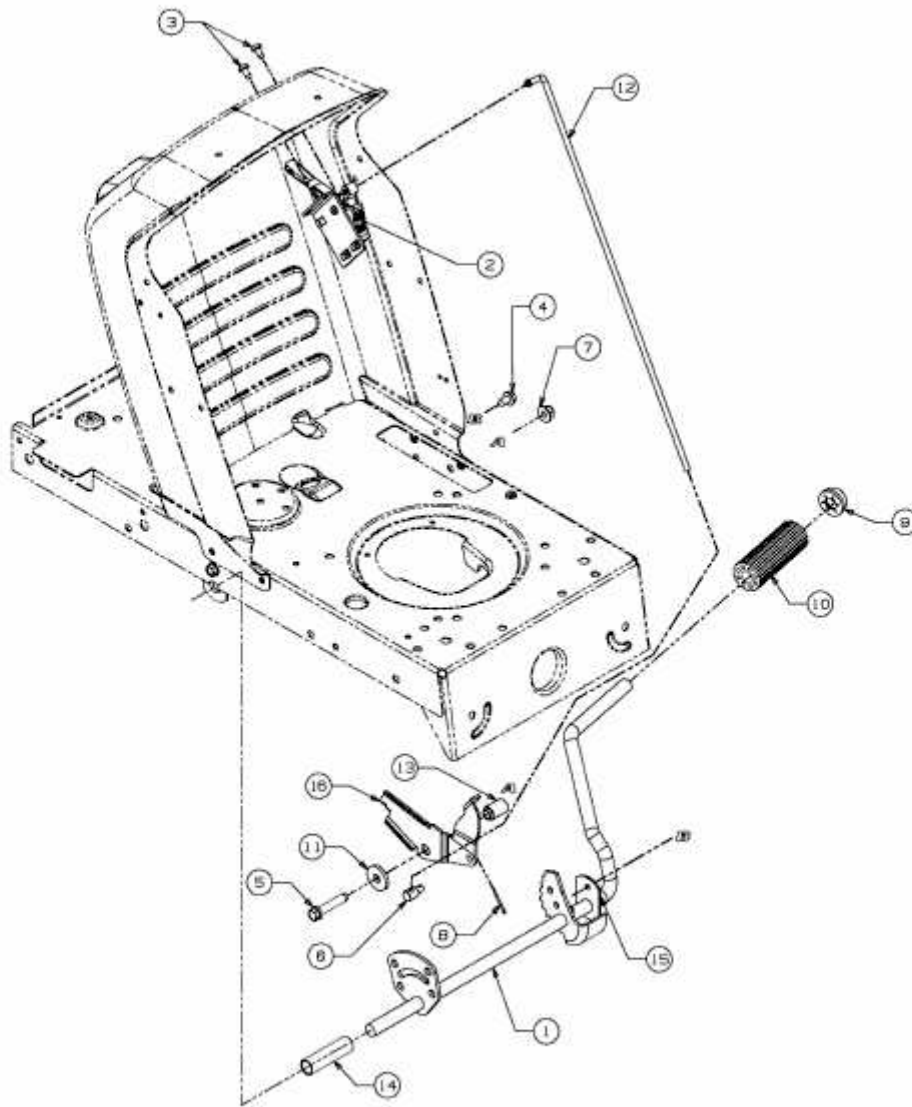

E3-02718A-01