

ab 02.12.2008
from 02.12.2008
à partir du 02.12.2008

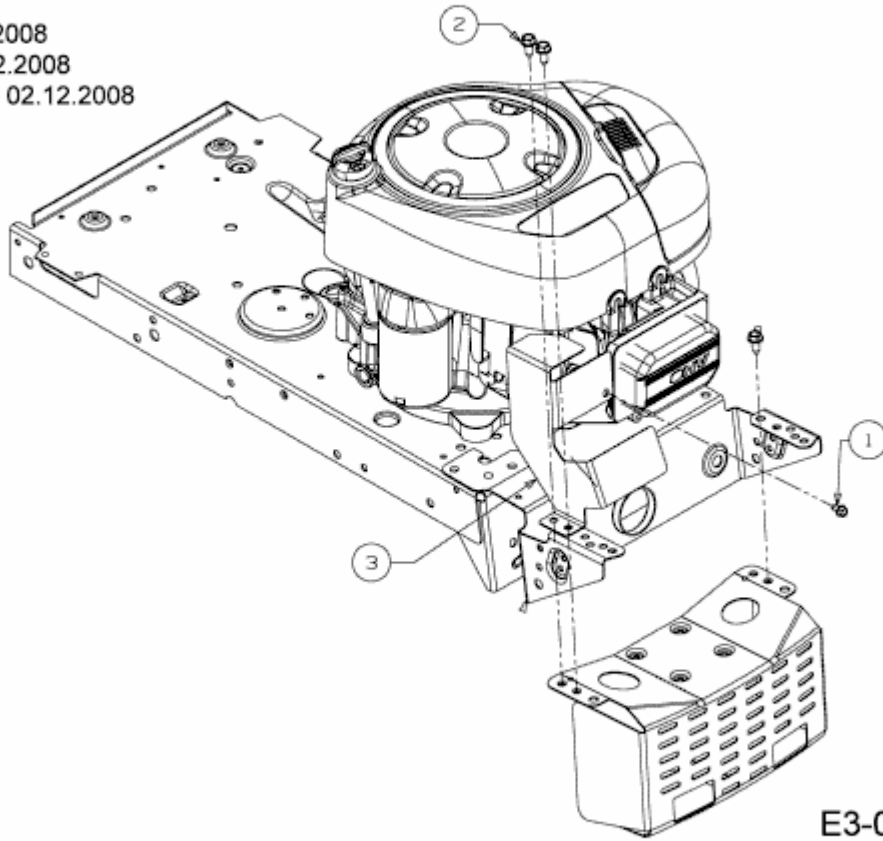

E3-03876A-02