

RS 125/96 B > 13AH762F600 (2009) > GESCHWINDIGKEITSREGELUNG

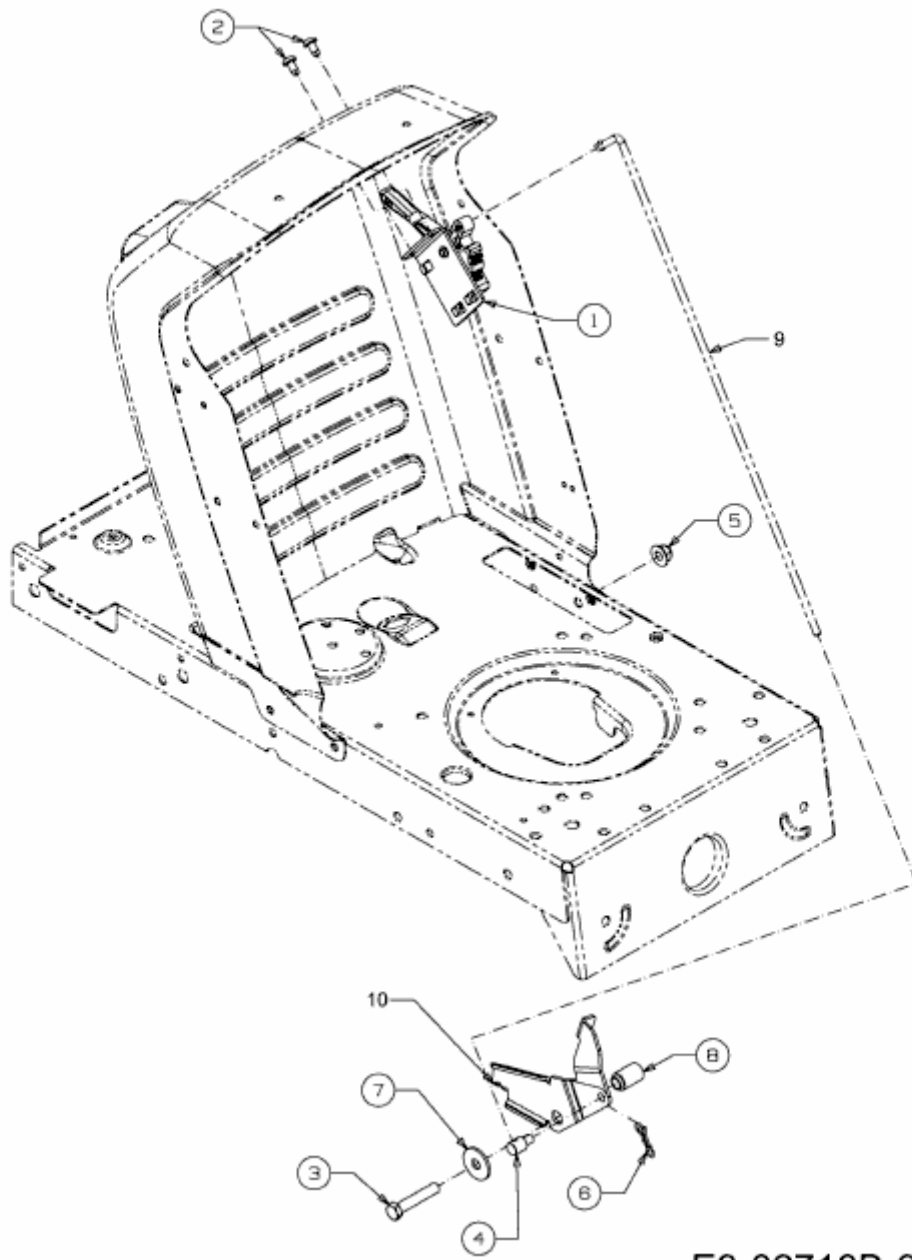

E3-02718B-01