

125-92 > 13AH761E680 (2011) > SCHALTPLAN

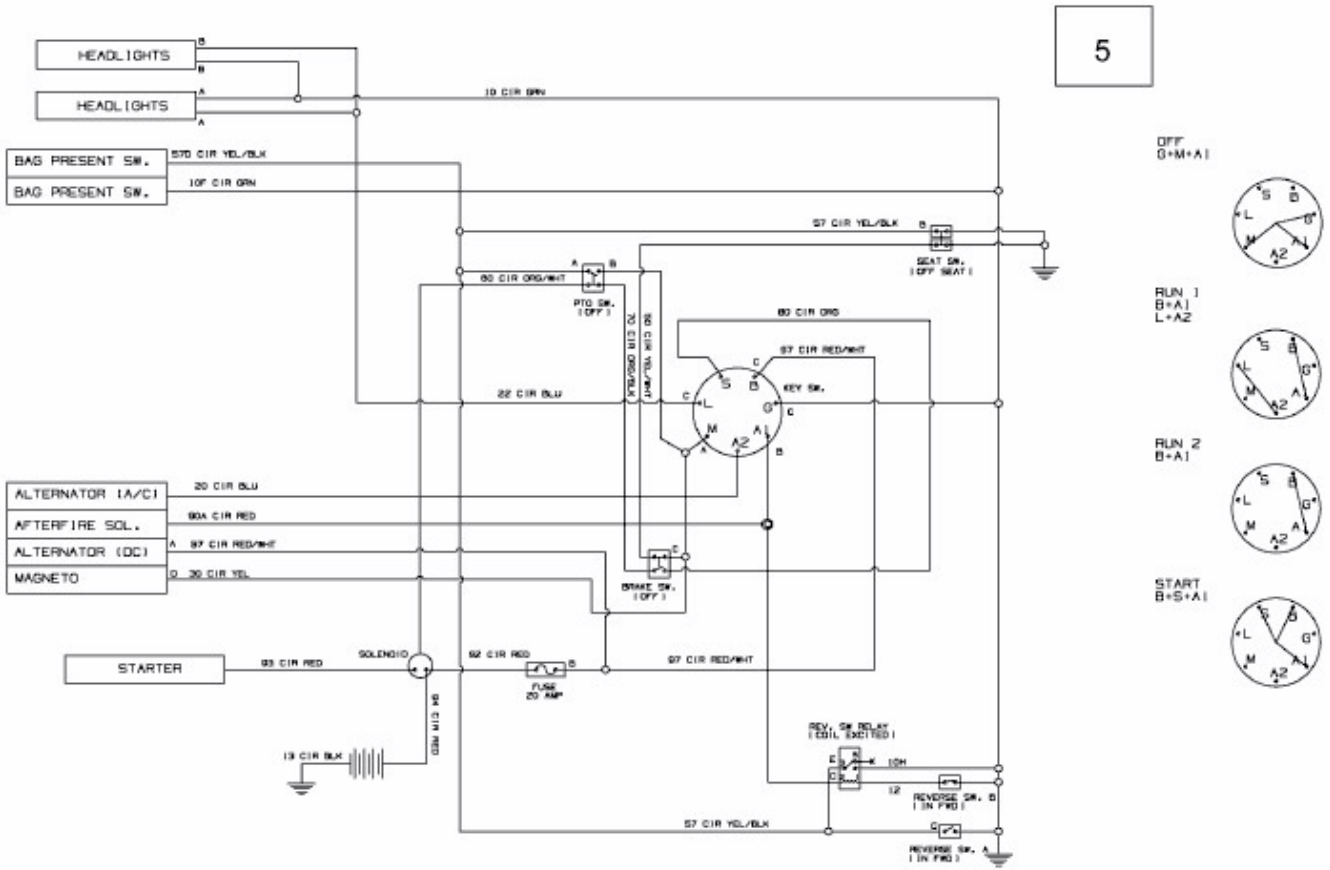

E3-03888D-02