

MASTERCUT 76 > 13AH761C659 (2009) > FAHRANTRIEB, PEDALE AB 16.01.2008

ab 16.01.2008  
from 16.01.2008  
à partir du 16.01.2008

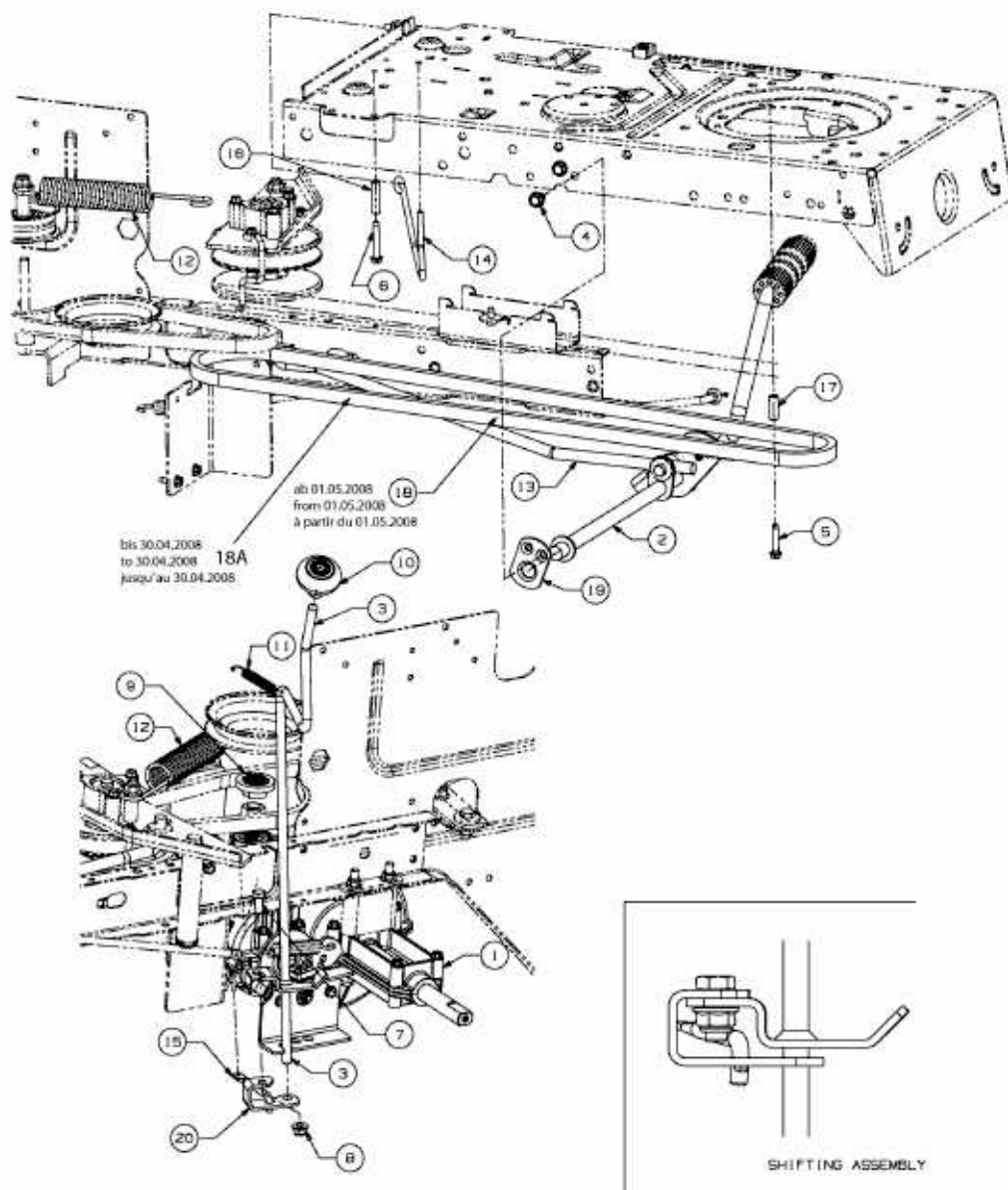

E3-03859B-01