

AT 100/07 > 13AH760F639 (2007) > TRITTBRETTBELAG

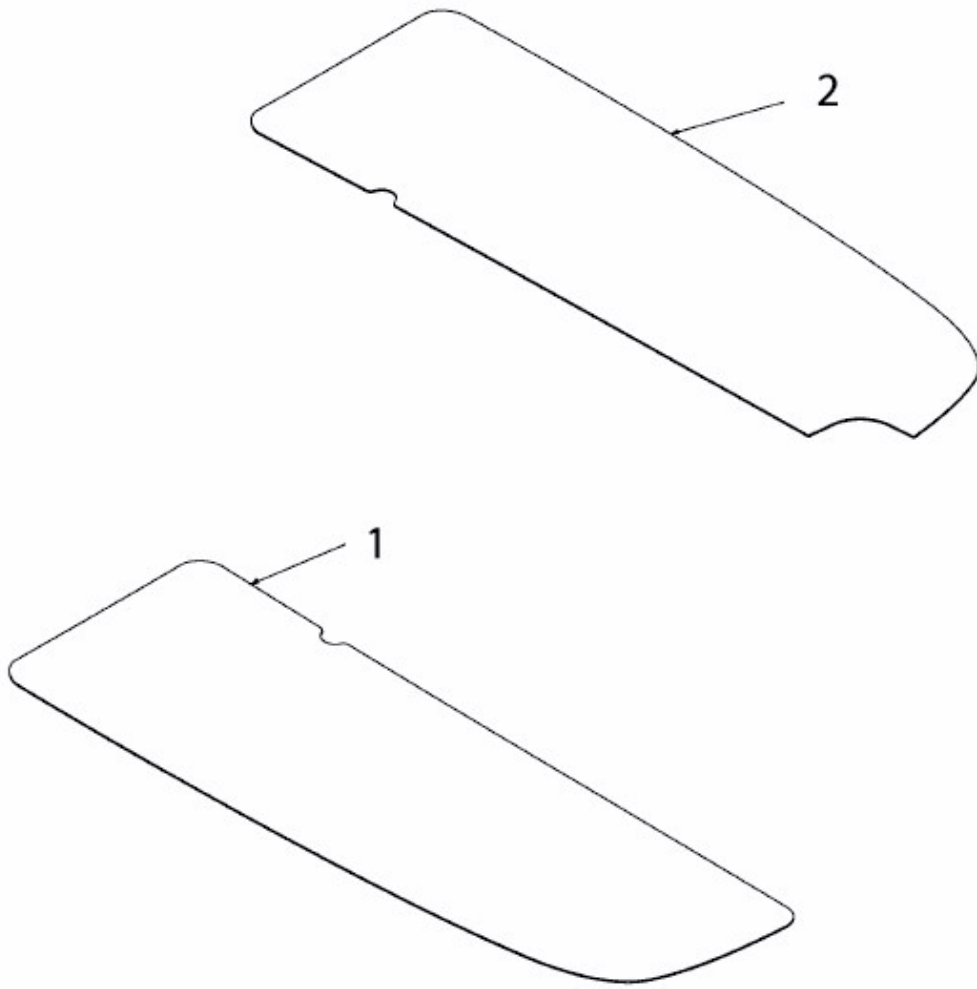

E3-02721A-01