

AT 100/08 > 13AH760F439 (2008) > TRITTBRETTBELAG

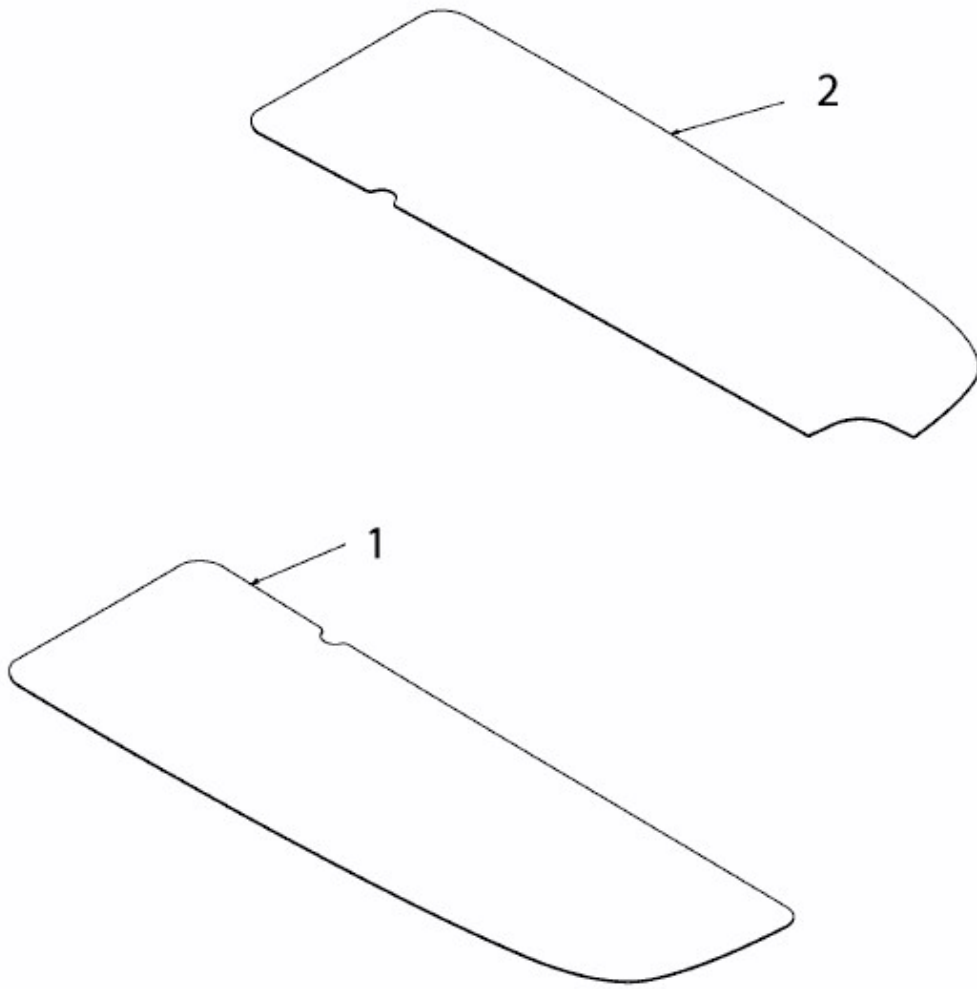

E3-02721A-01