

AT 100/08 > 13AH760F439 (2008) > LENKRAD MIT LOGO

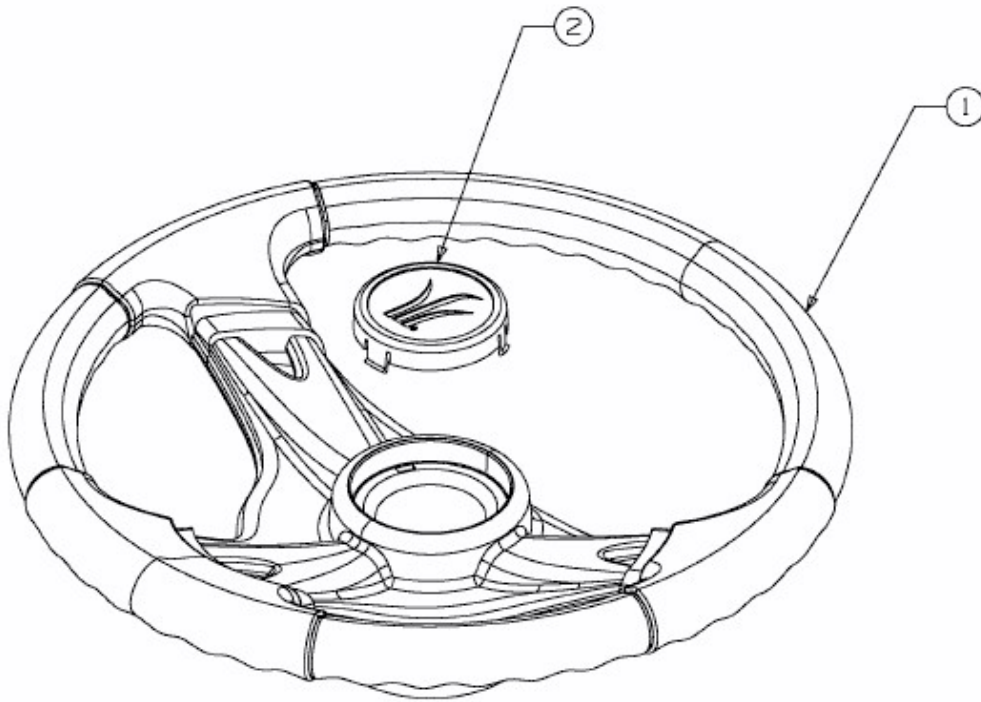

E3-02014A-01