

SMART RE 130 H > 13AH715E600 (2014) > MOTORKEILRIEMENSCHLEIBE

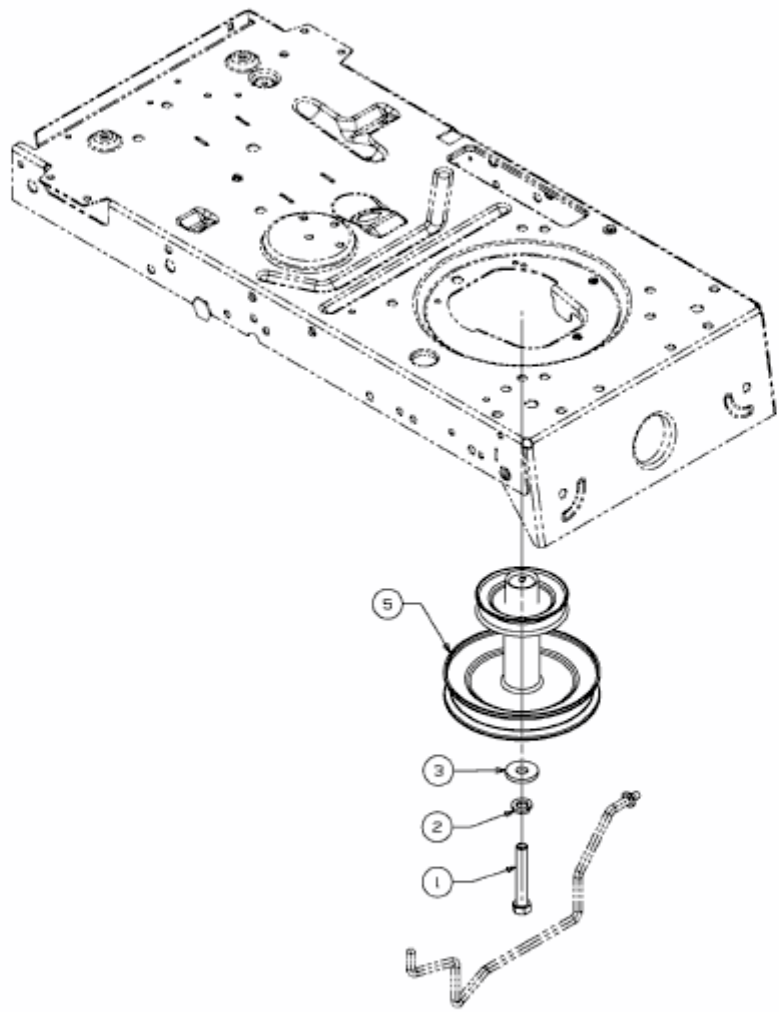

E3-05557A-01