

SMART RE 130 H > 13AH715E600 (2014) > TRITTBRETTBELAG

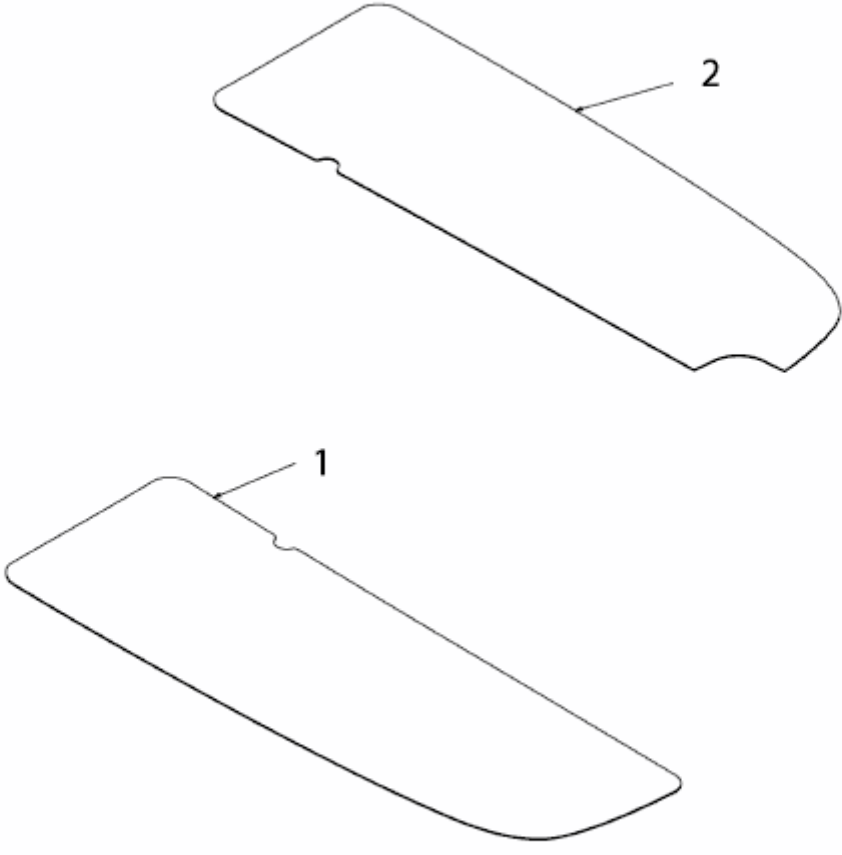

E3-02721A-01