

SMART RE 130 H > 13AH715E600 (2014) > ACHSSCHENKEL

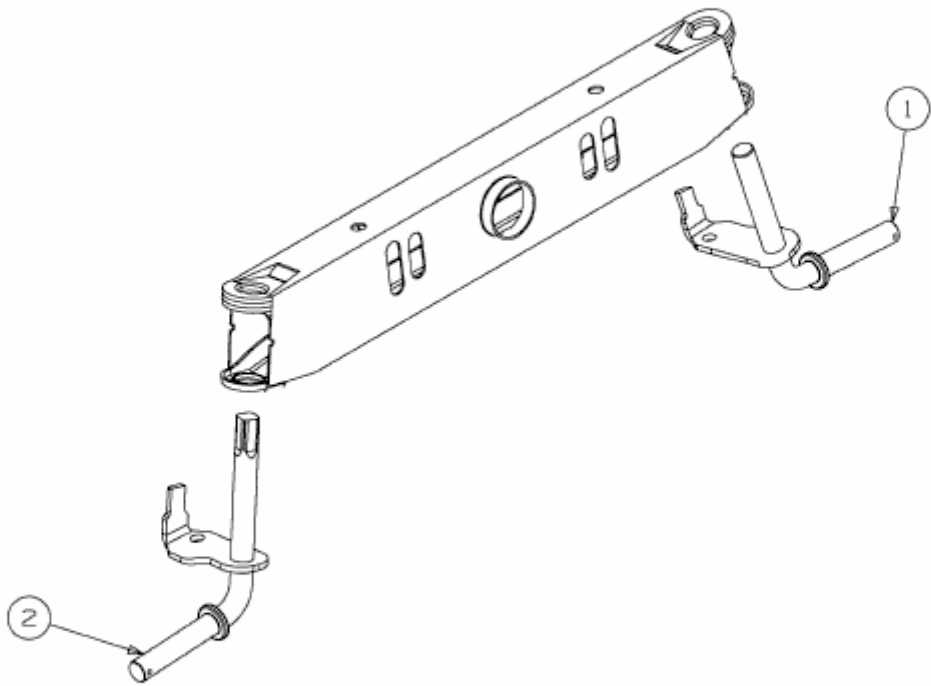

E3-03882A-01