

703 > 13AH489E611 (2007) > VORDERACHSE

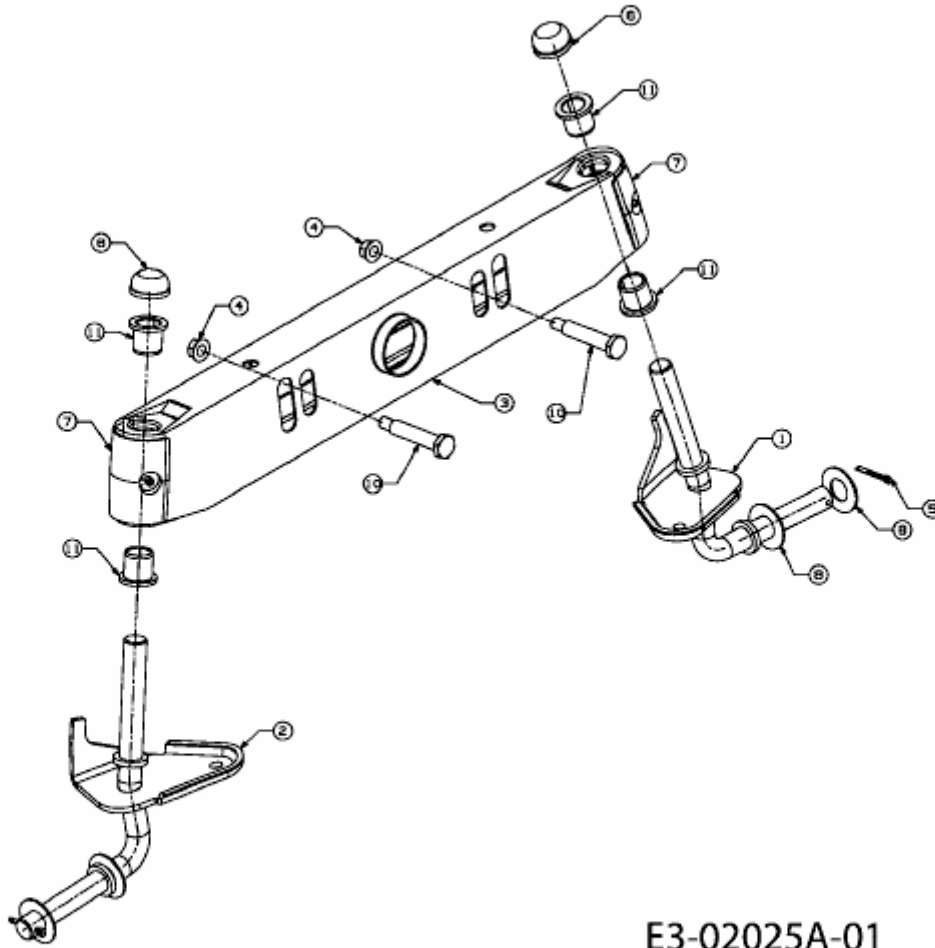

E3-02025A-01