

703 > 13AH489E611 (2005) > LENKRAD MIT LOGO

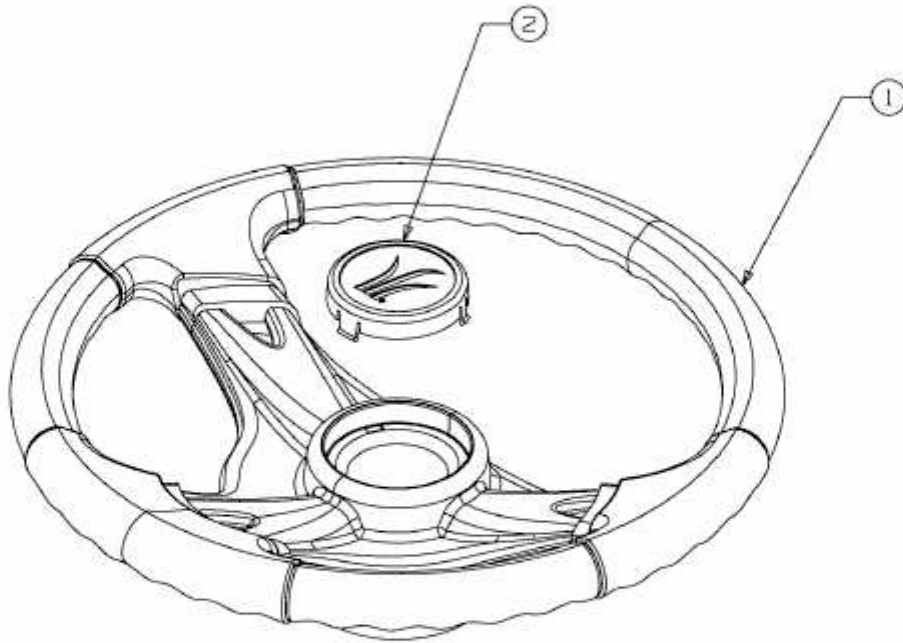

E3-02014A-01