

125/96 > 13AH455F600 (2003) > MÄHWERKSAUSHEBUNG

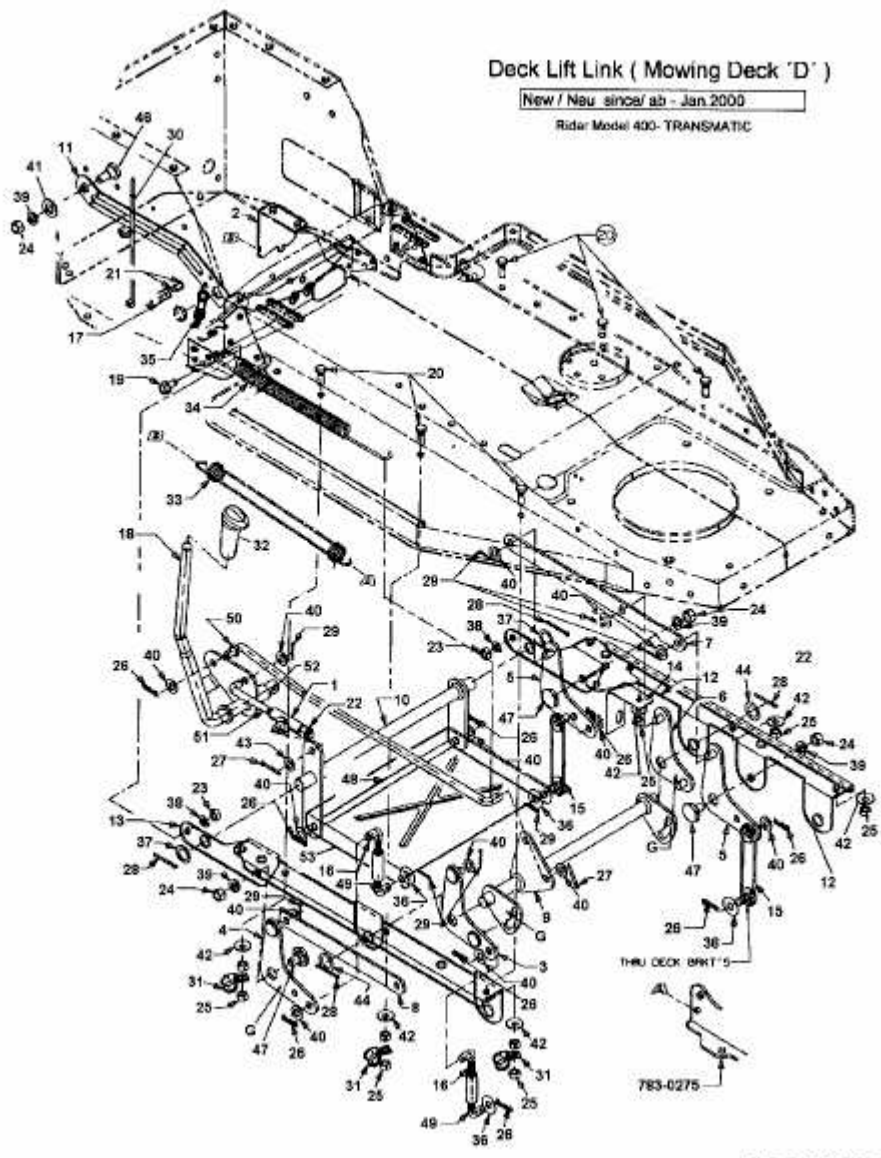

Fig

E3-01591A-01