

ab 01/09/2018
from 09/01/2018
à partir du 01/09/2018

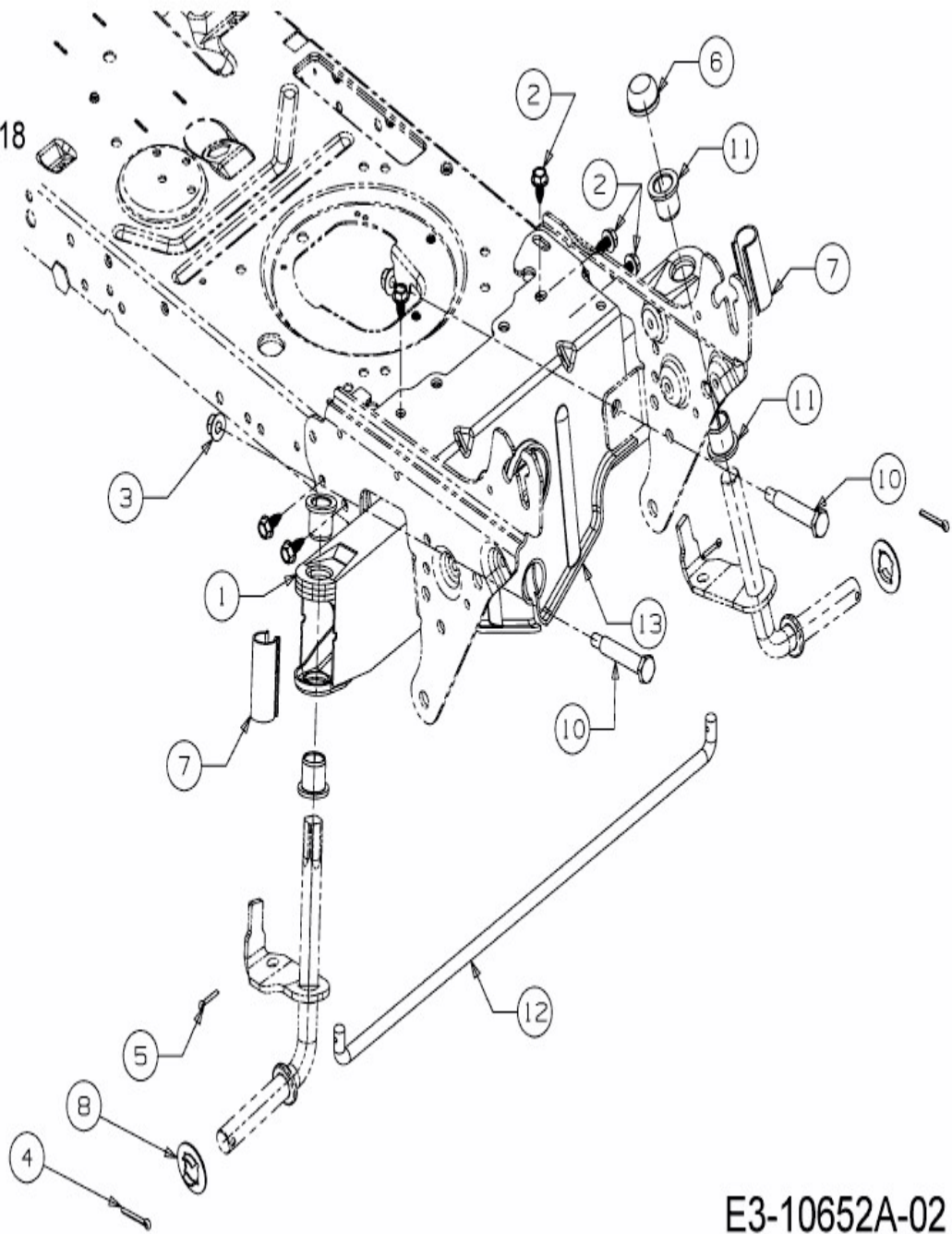

E3-10652A-02