

HE 5150 K > 13AG51YE643 (2009) > HIGH LIFT MESSER

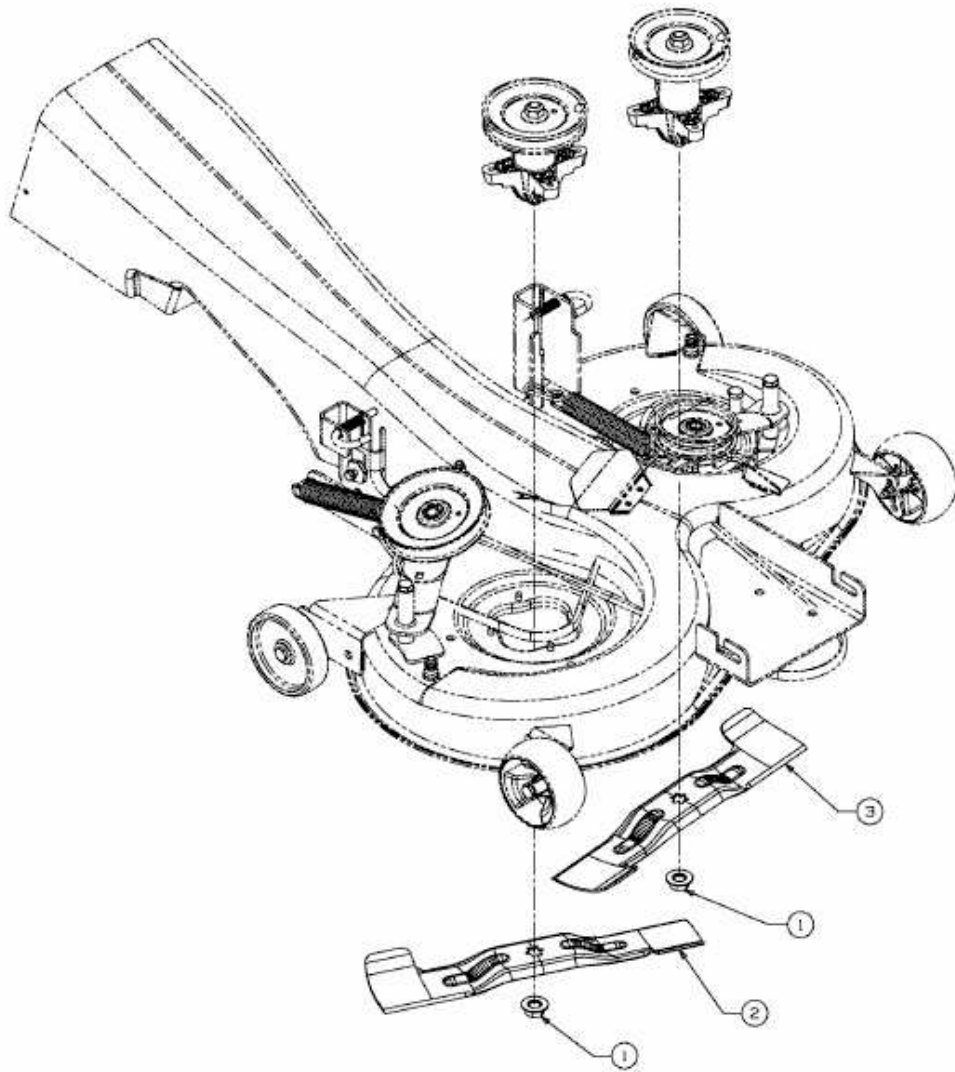

E3-03075A-01