

HE 5150 K > 13AG51YE443 (2009) > FÜLLSTANDSANZEIGE

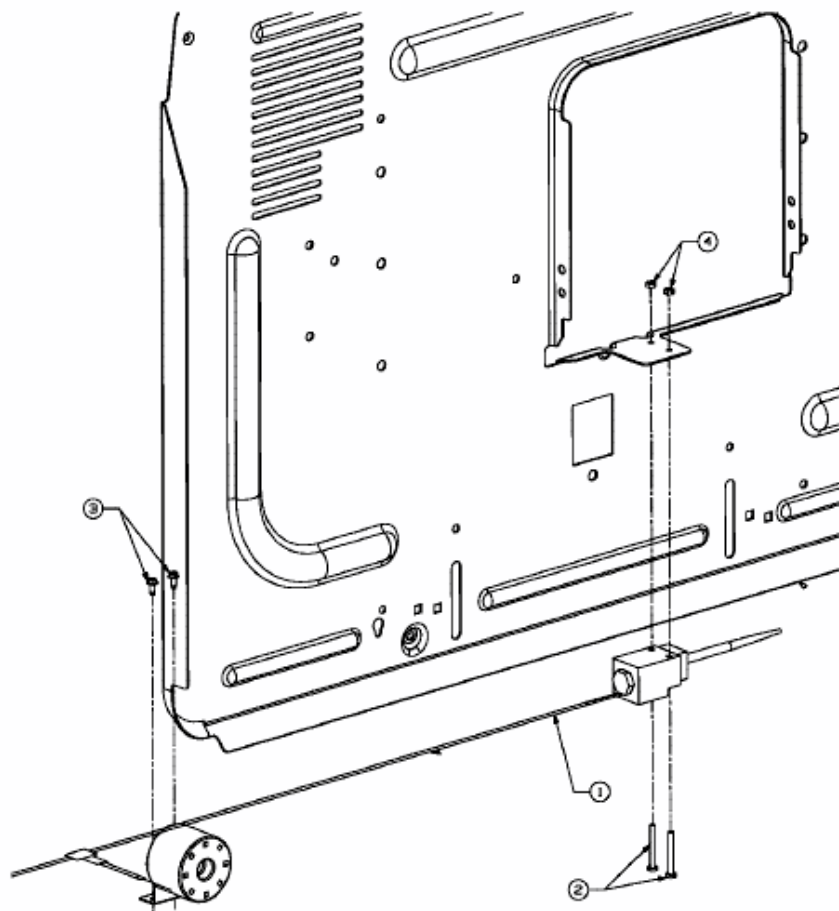

E3-02081B-01