

HE 5150 K > 13AG51YE443 (2009) > CHOKEZUG

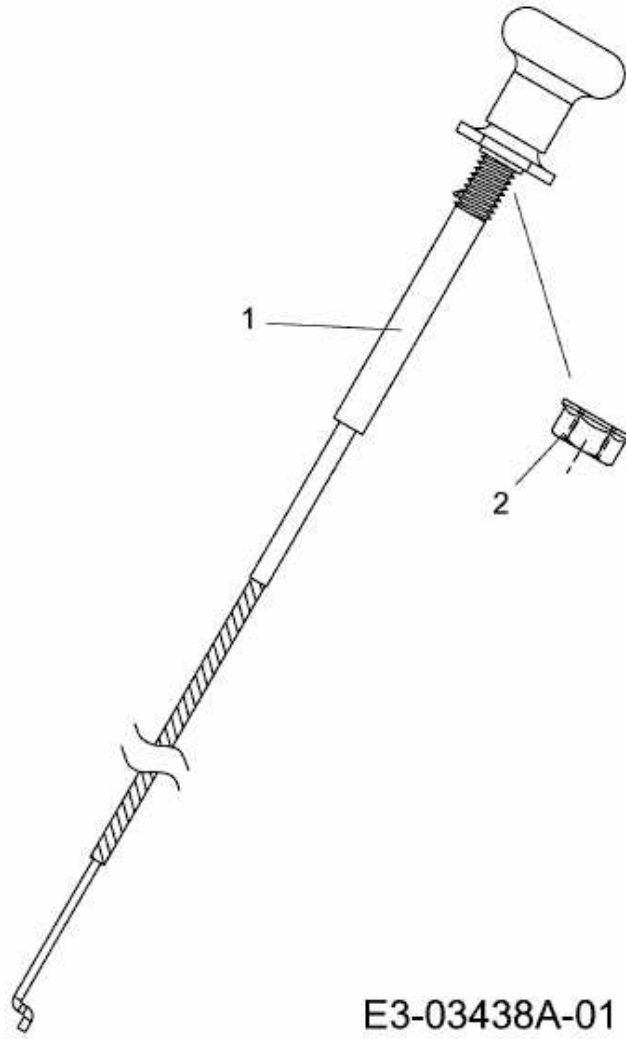

E3-03438A-01