

KOMMAND 105/22 HPLUS > 13AF99KN637 (2012) > MOTORZUBEHÖR

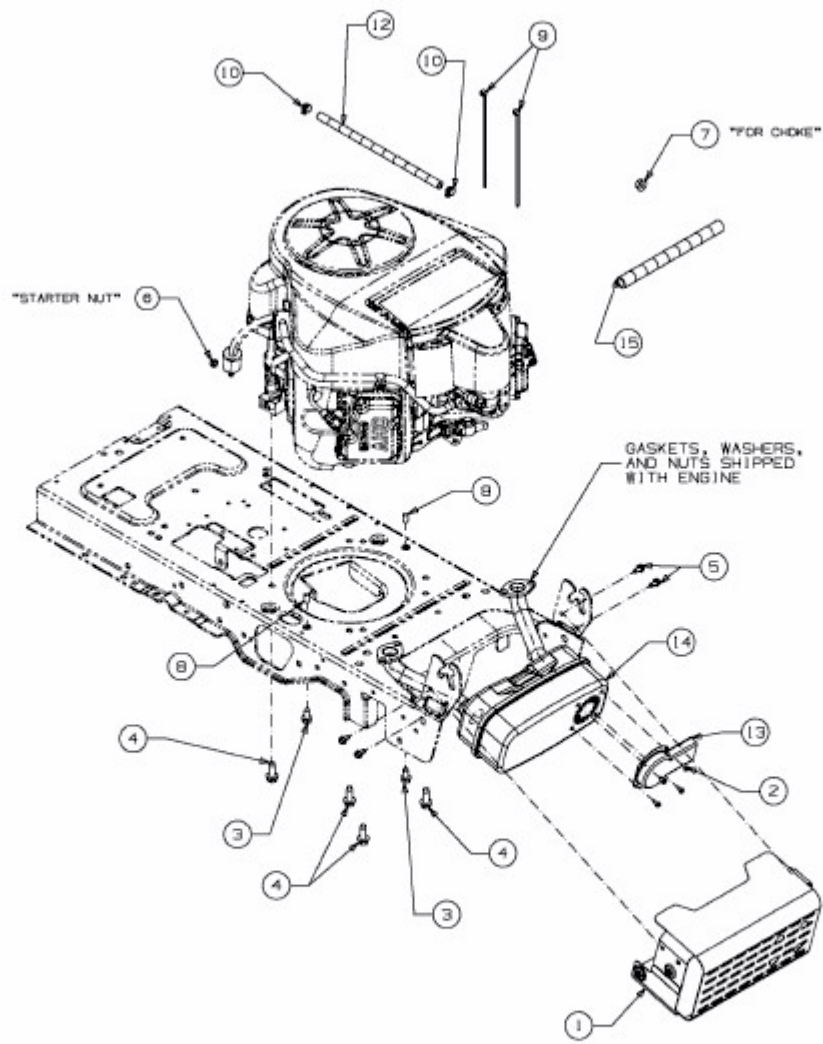

E3-07563A-01