

ab 02.10.2001
from 02.10.2001
à partir du 02.10.2001

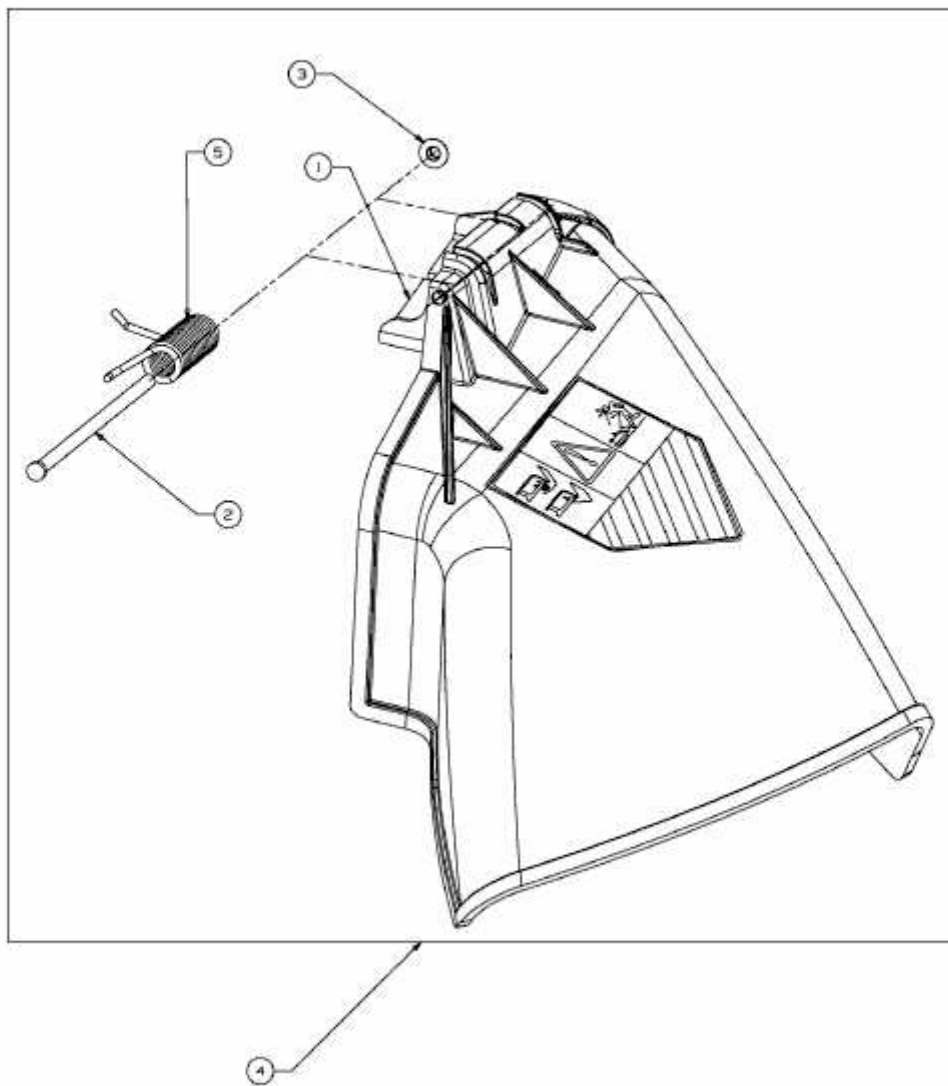

E3-04592A-01