

ab 01.11.2007  
from 01.11.2007  
à partir du 01.11.2007

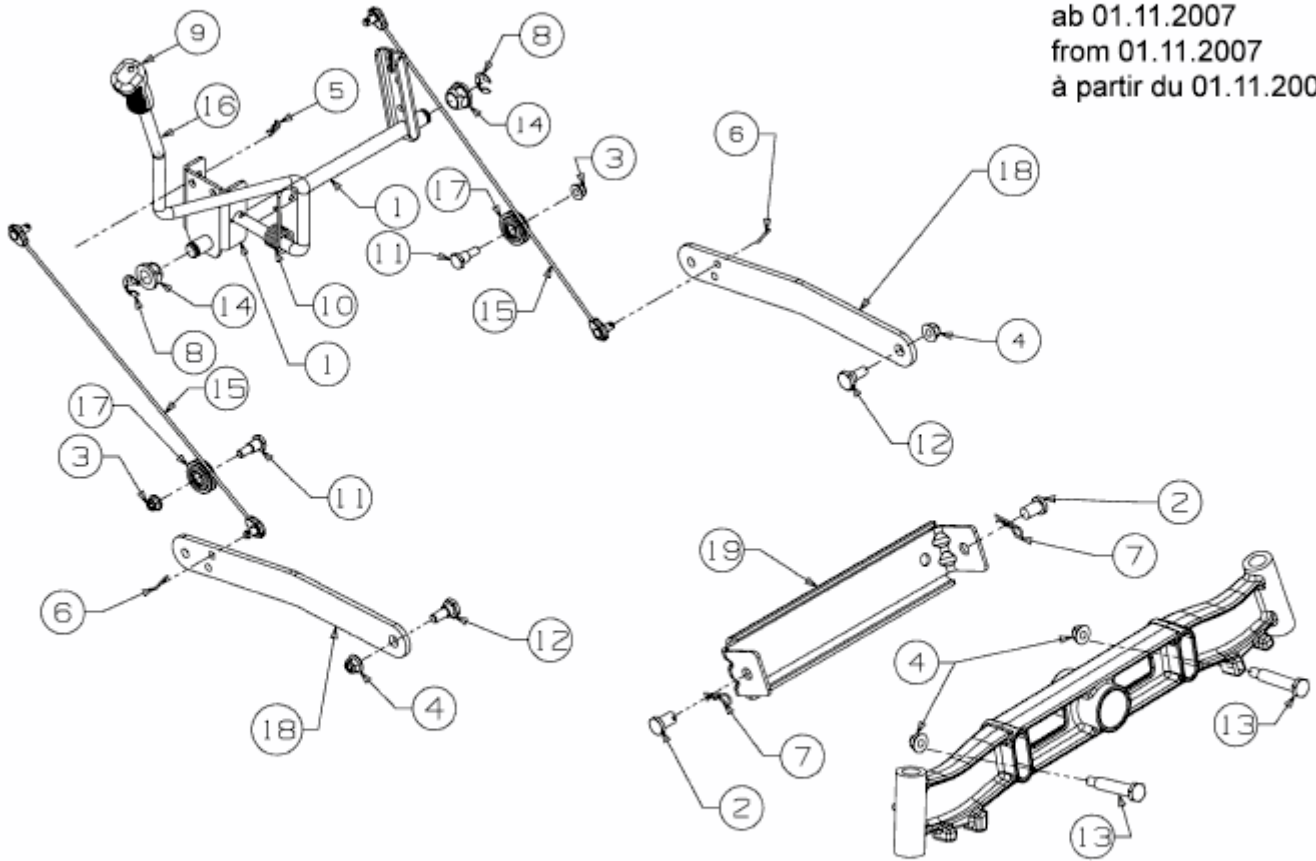

E3-04336A-01