

HN 5220 K > 13AF51YN443 (2010) > HIGH LIFT MESSER

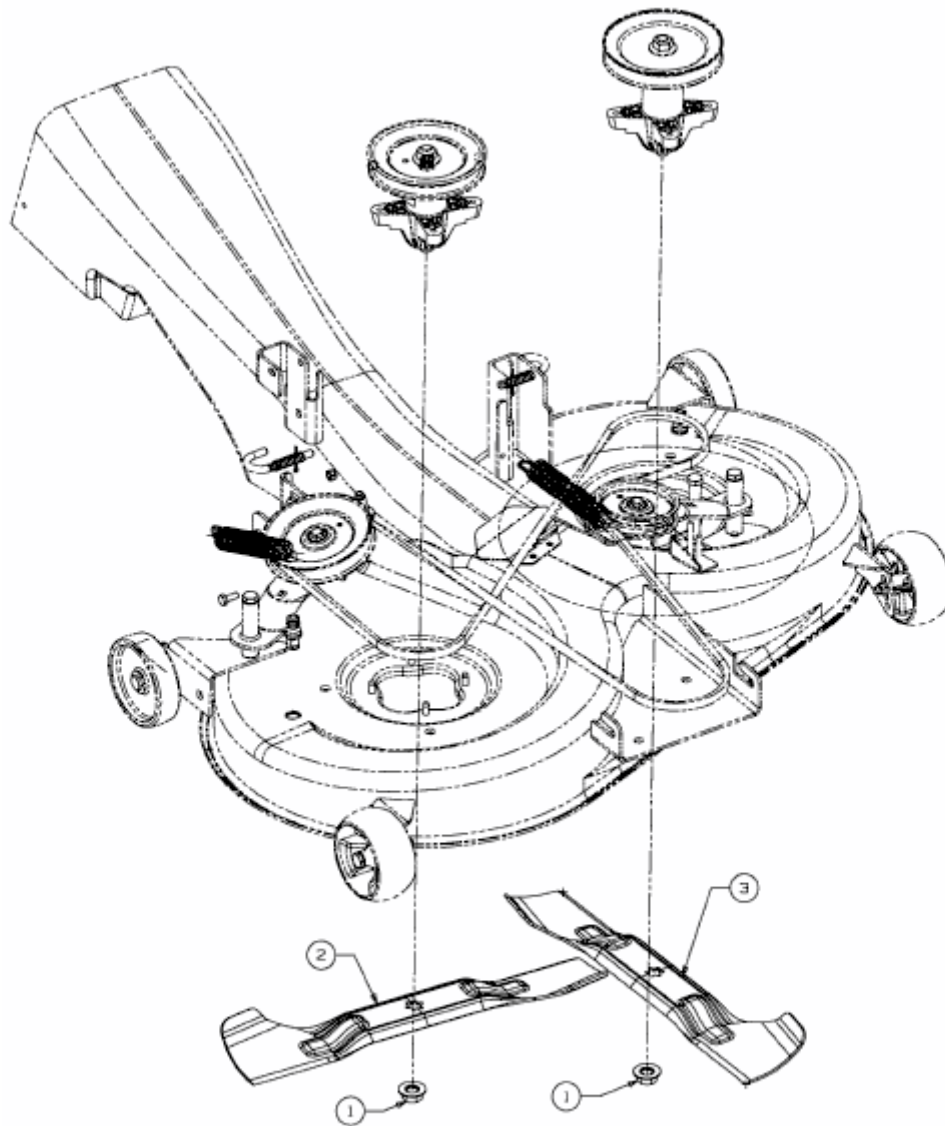

E3-03077A-01