

HN 5220 K > 13AF51YN443 (2010) > GRASFANGVORRICHTUNG

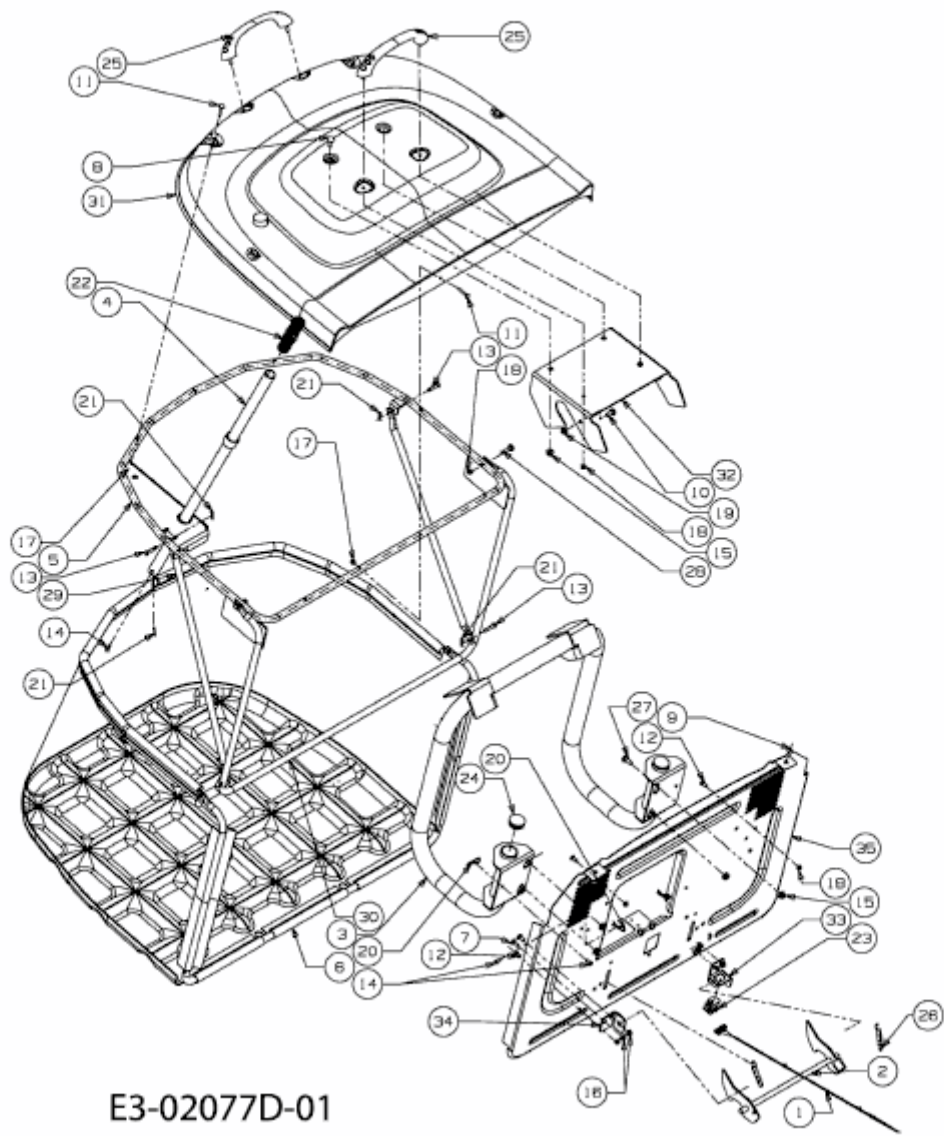

E3-02077D-01