

HN 5220 K > 13AF51YN443 (2009) > FÜLLSTANDSANZEIGE

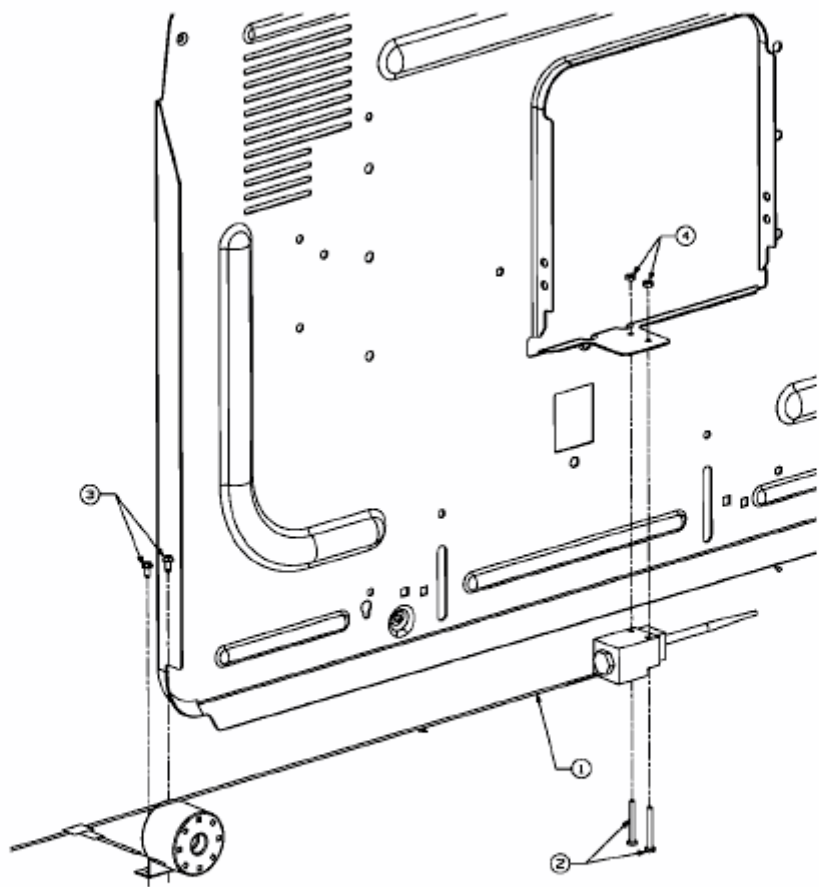

E3-02081B-01