

HN 5220 K > 13AF51YN443 (2009) > CHOKEZUG

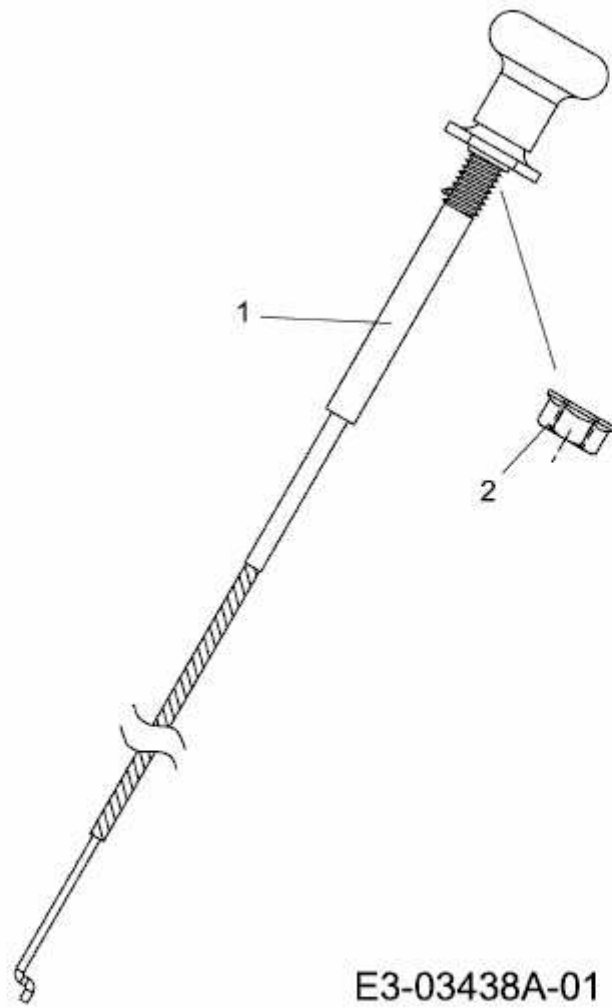

E3-03438A-01