

HS 5220 K > 13AF51YI643 (2009) > CHOKEZUG

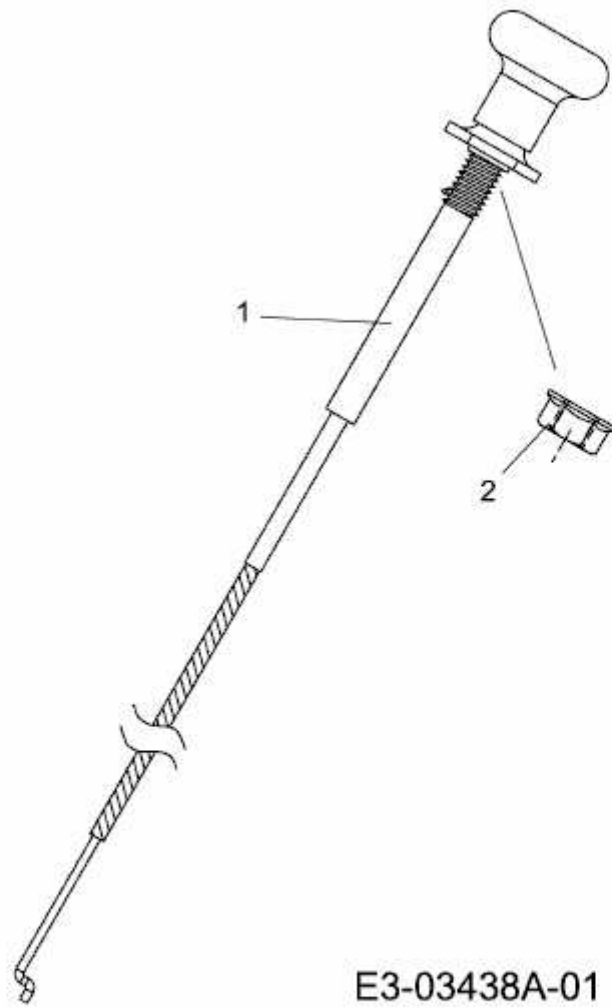

E3-03438A-01