

GLX 105 RHL-SK > 13AF51GN690 (2009) > SITZWANNE

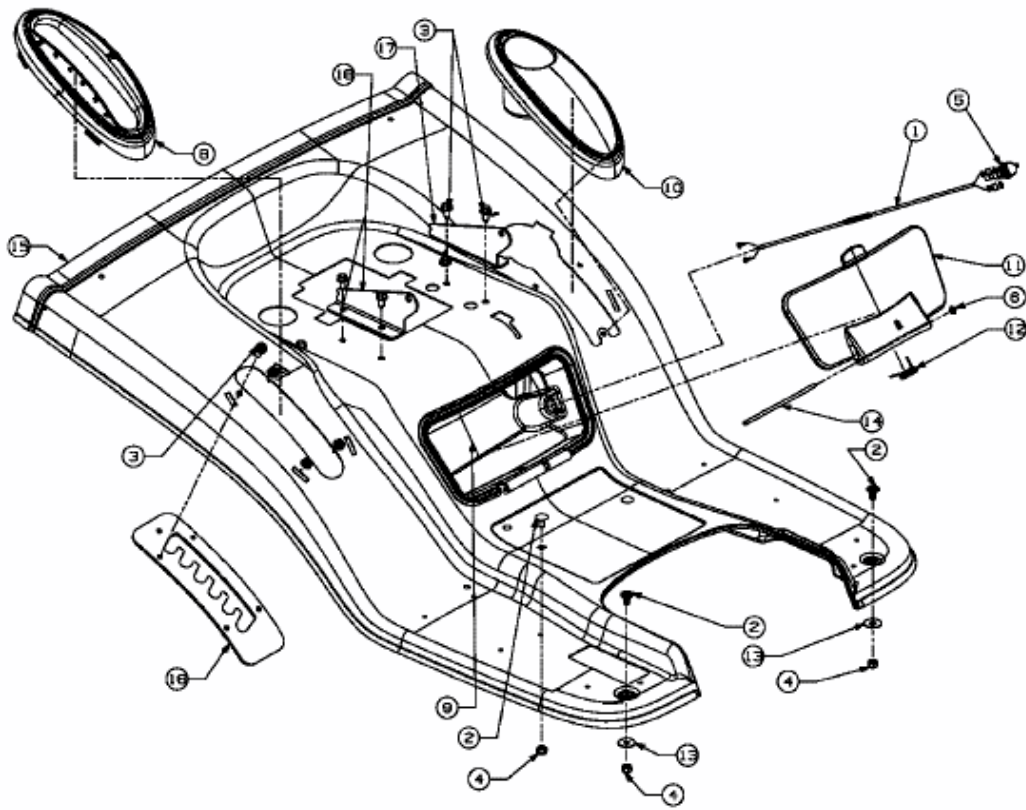

E3-02046C-01