

GLX 105 RHL-SK > 13AF51GN690 (2009) > SITZTRÄGER

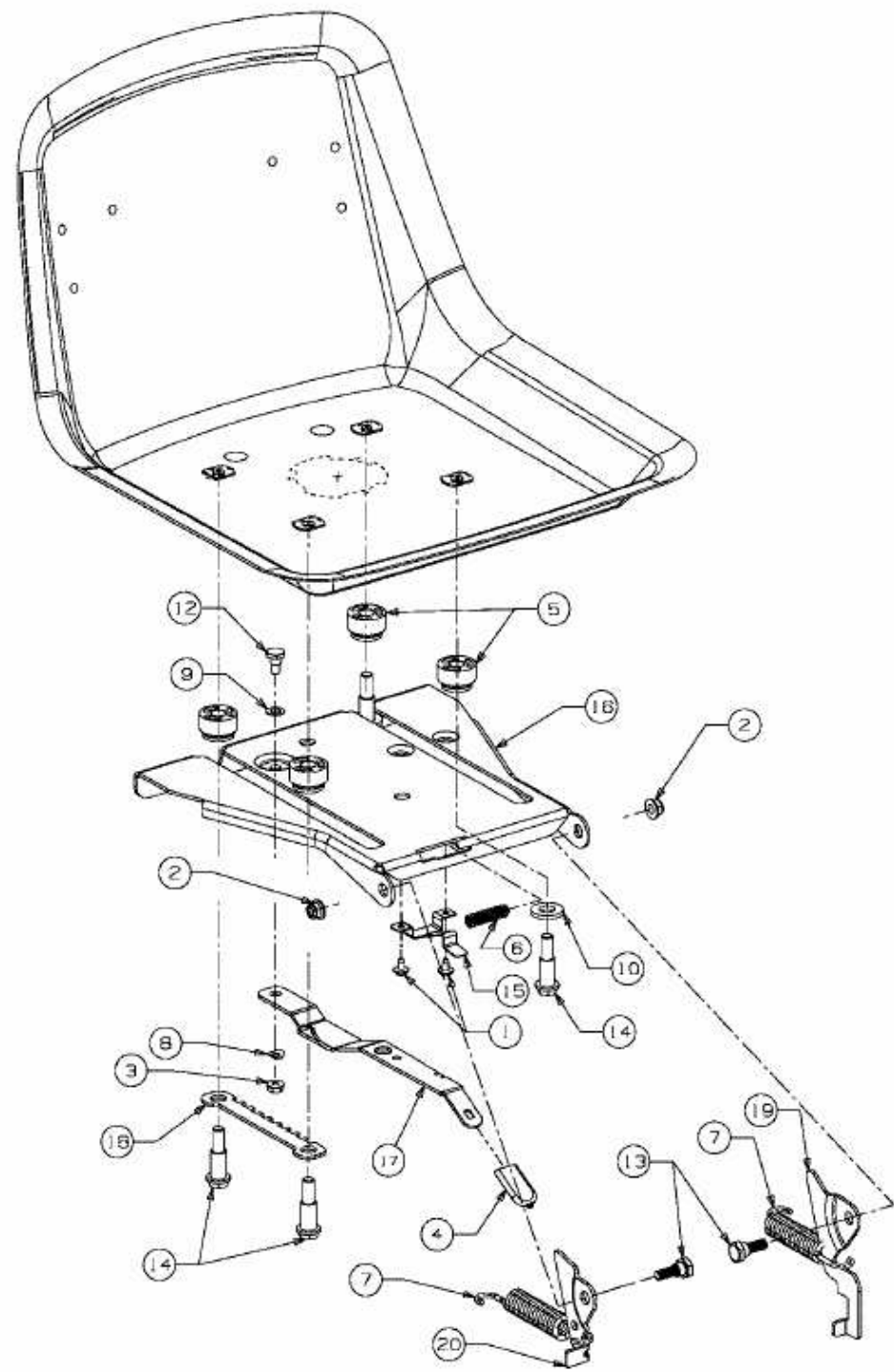

E3-02342B-01