

GLX 92 SHL-SK > 13AF51GI690 (2009) > SITZTRÄGER

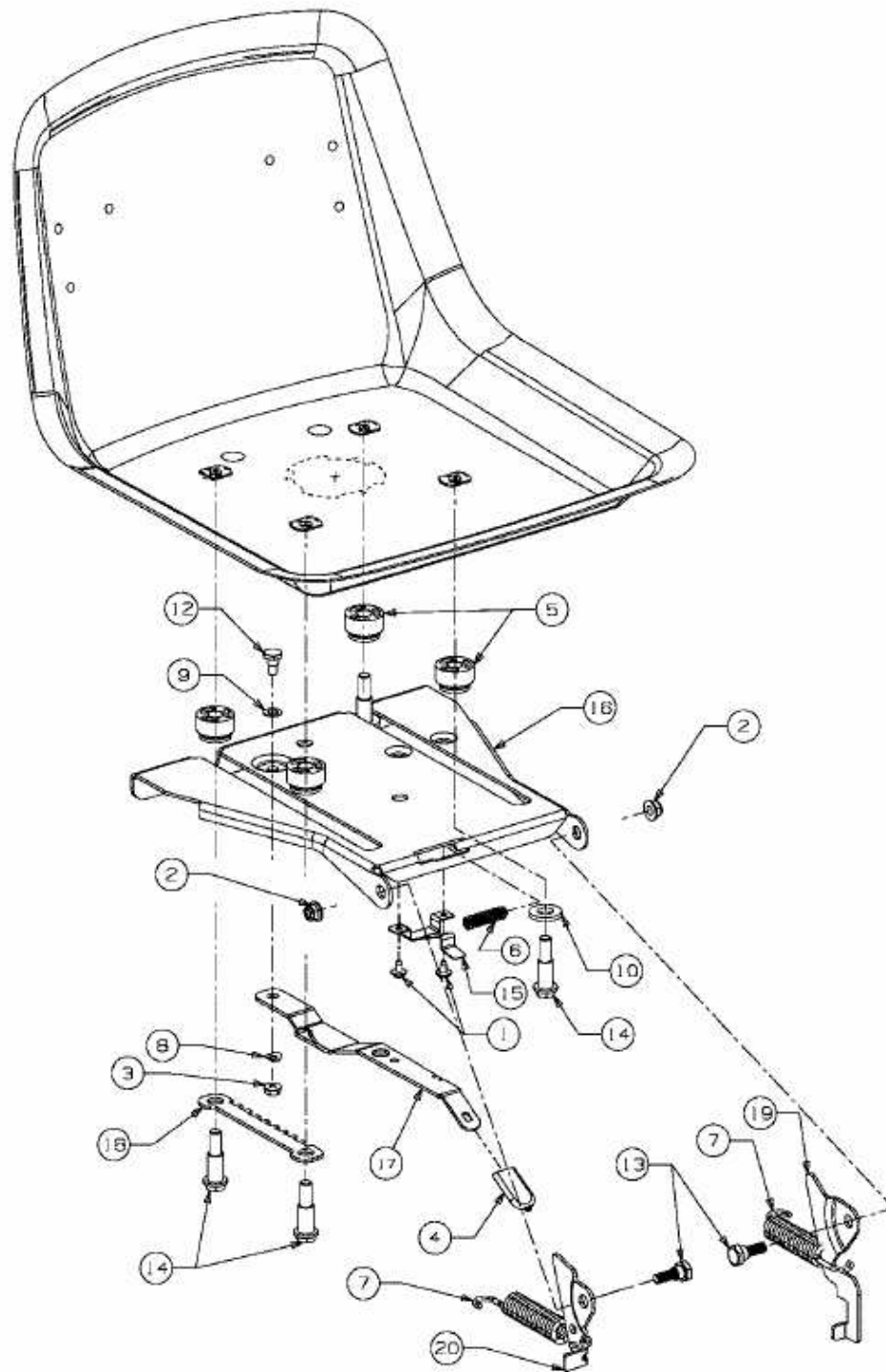

E3-02342B-01