

GLX 92 SHL-SK > 13AF51GI690 (2009) > CHOKEZUG

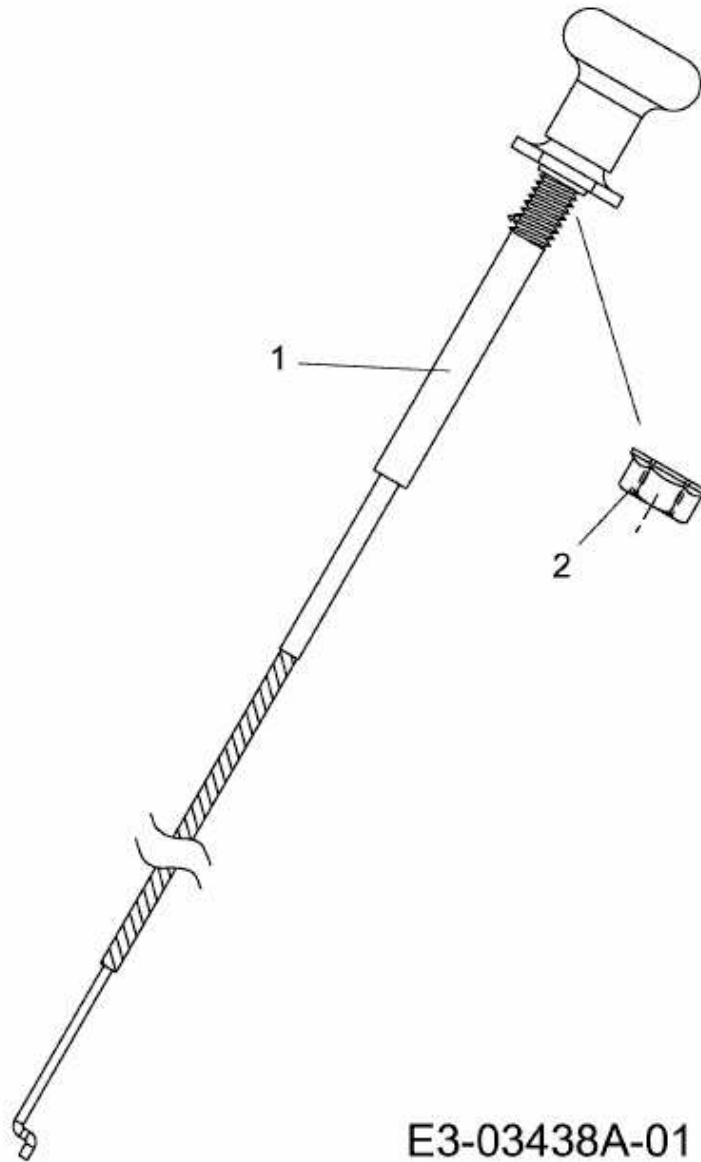

E3-03438A-01