

ab 01.12.2005  
from 01.12.2005  
à partir du 01.12.2005

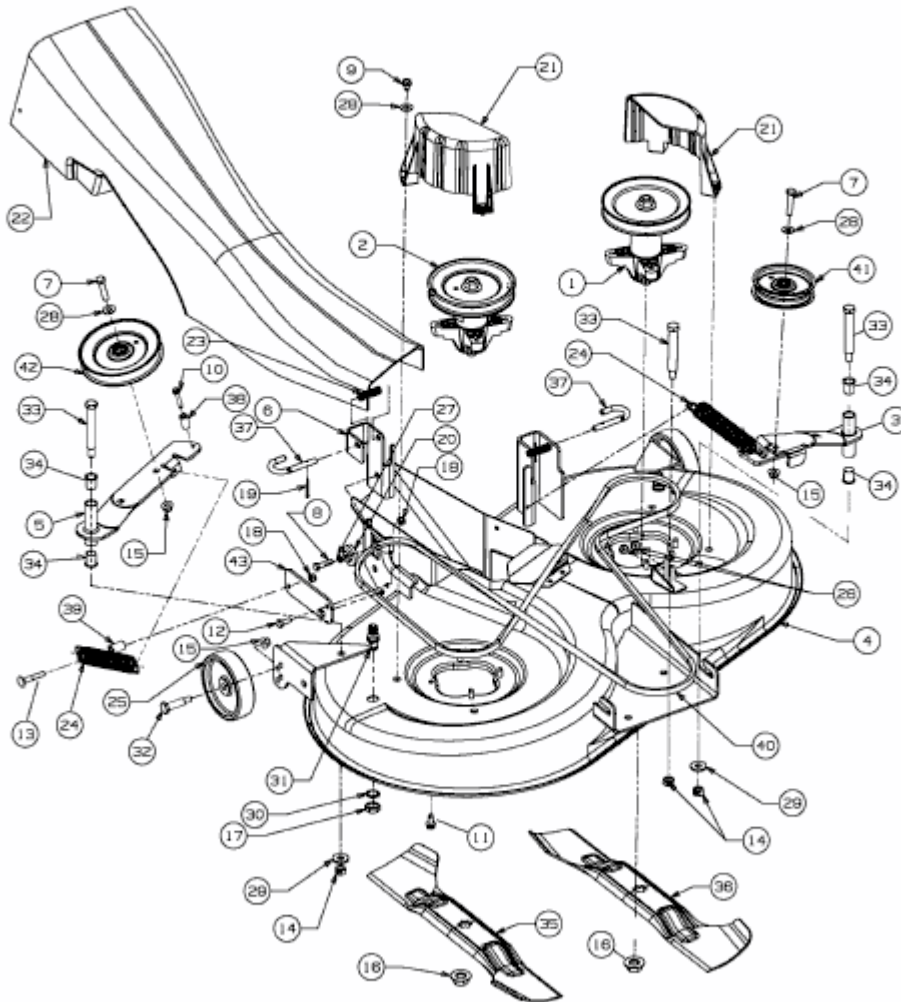

E3-02417A-02