

ab 11.12.2004  
from 11.12.2004  
à partir du 11.12.2004

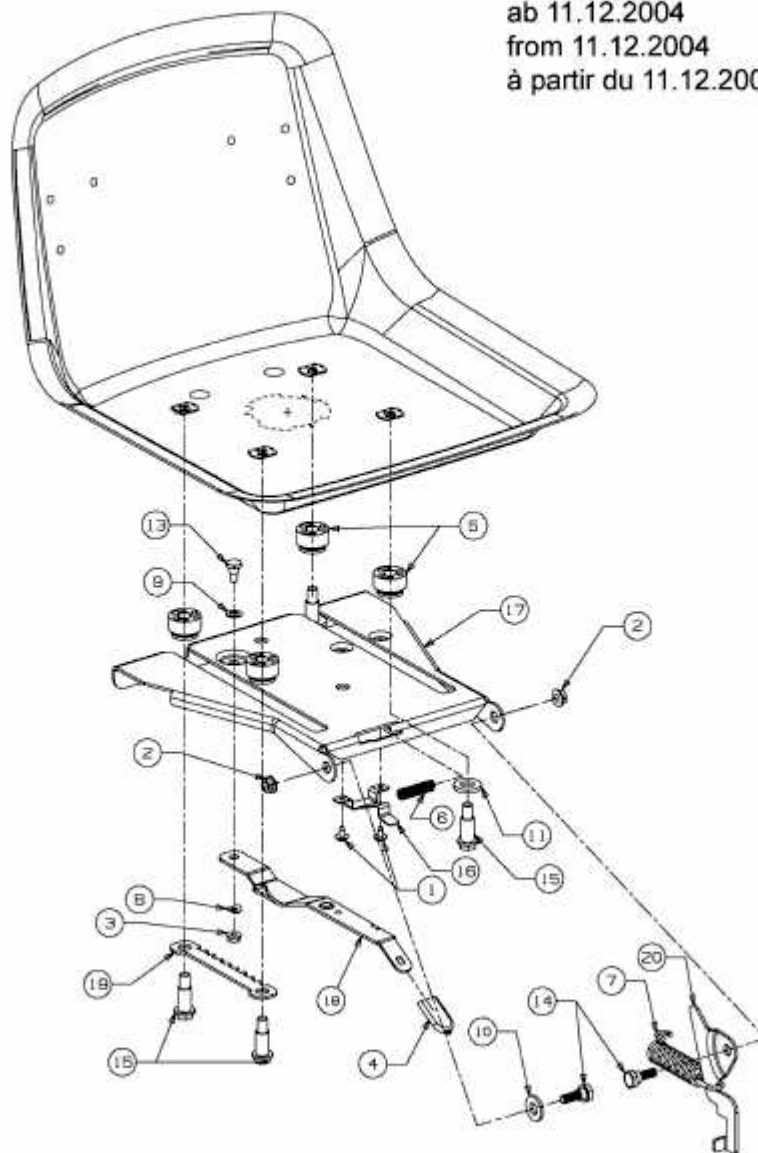

E3-02352A-02