

CC 1018 RD > 13AE51CE603 (2007) > MÄHWERKSEINSCHALTUNG

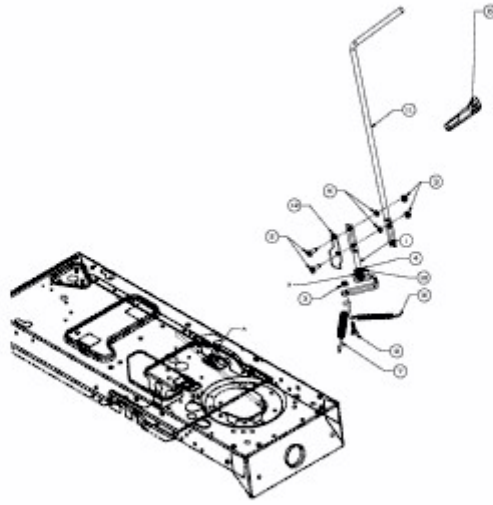

E3-02410A-01