

AE 4160 > 13AE404E643 (2002) > BATTERIE, RAHMEN, SITZWANNE

RIDER 400 - AUTO DRIVE

RIDER 400 - TRANSMATIC

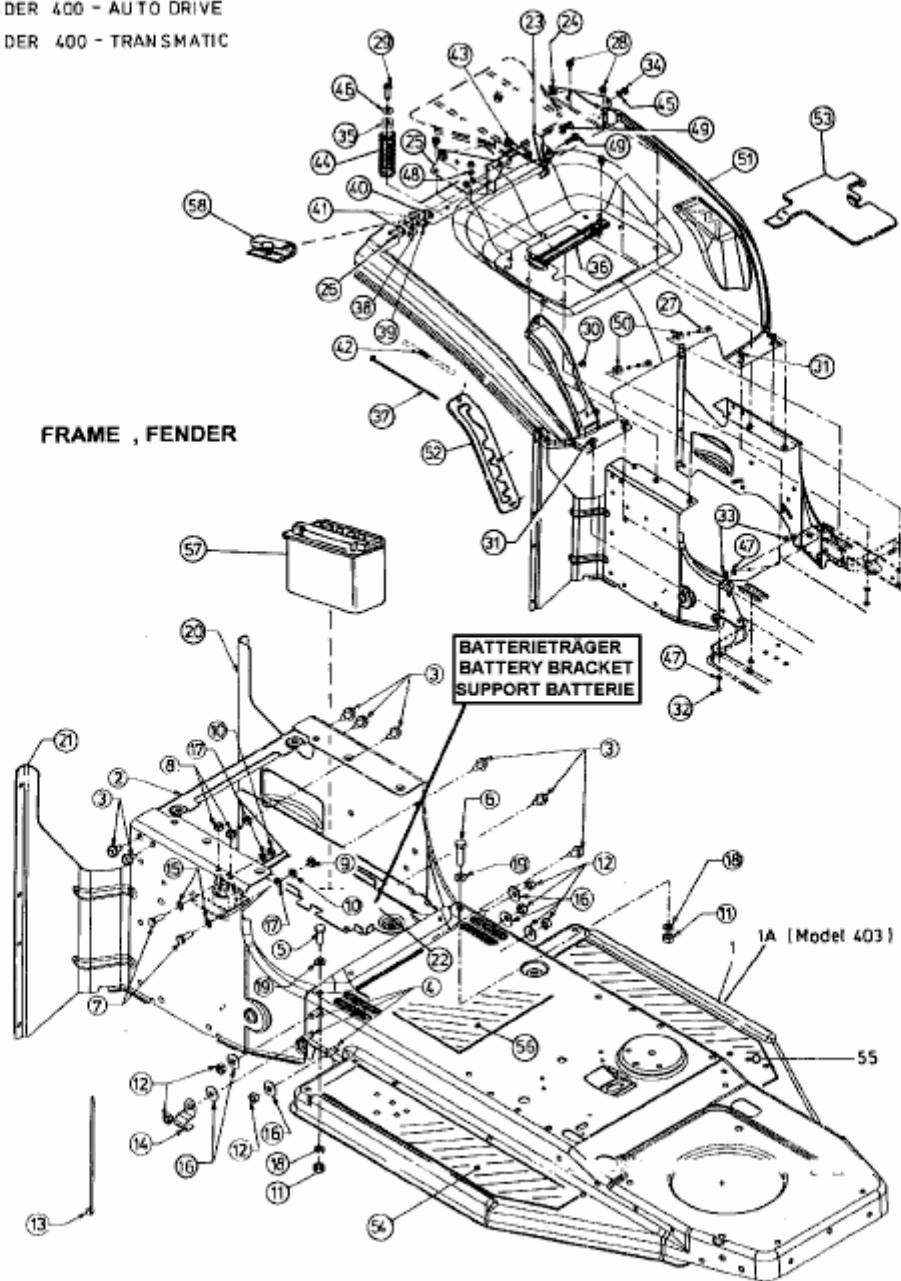

E3-01438 C