

ab 15.11.2006
from 15.11.2006
à partir du 15.11.2006

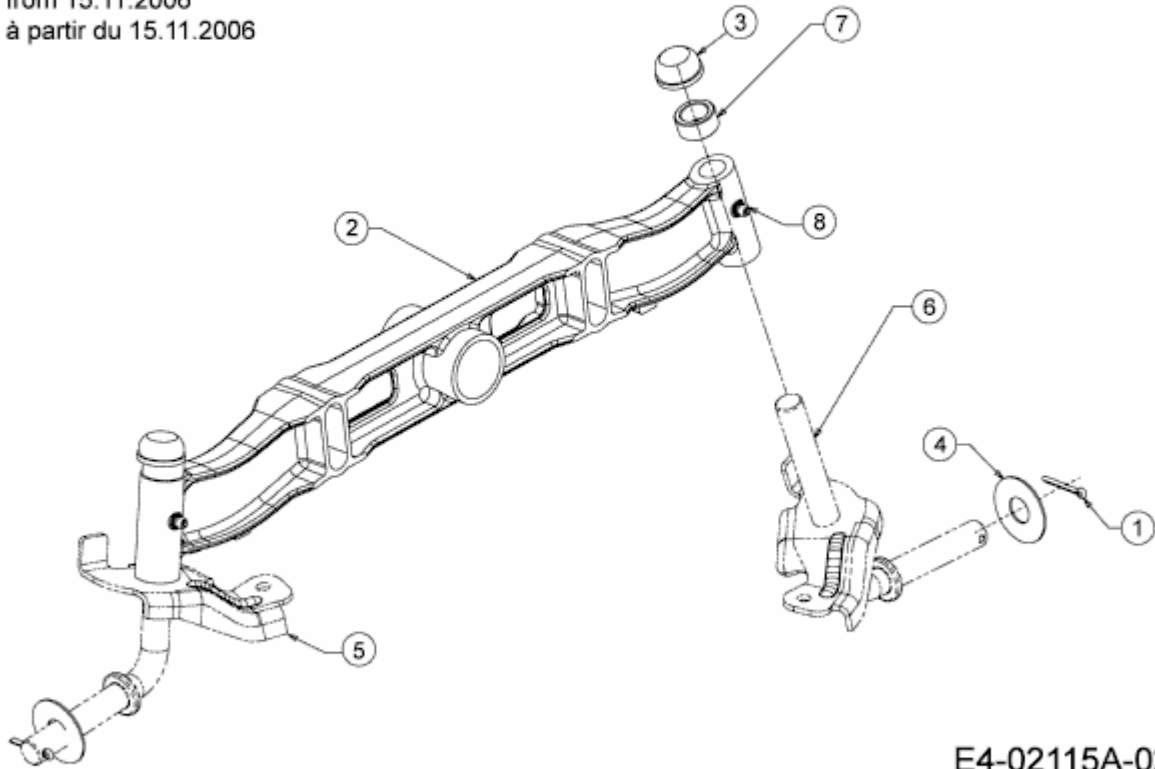

E4-02115A-02