

ab 19.12.2006
from 19.12.2006
à partir du 19.12.2006

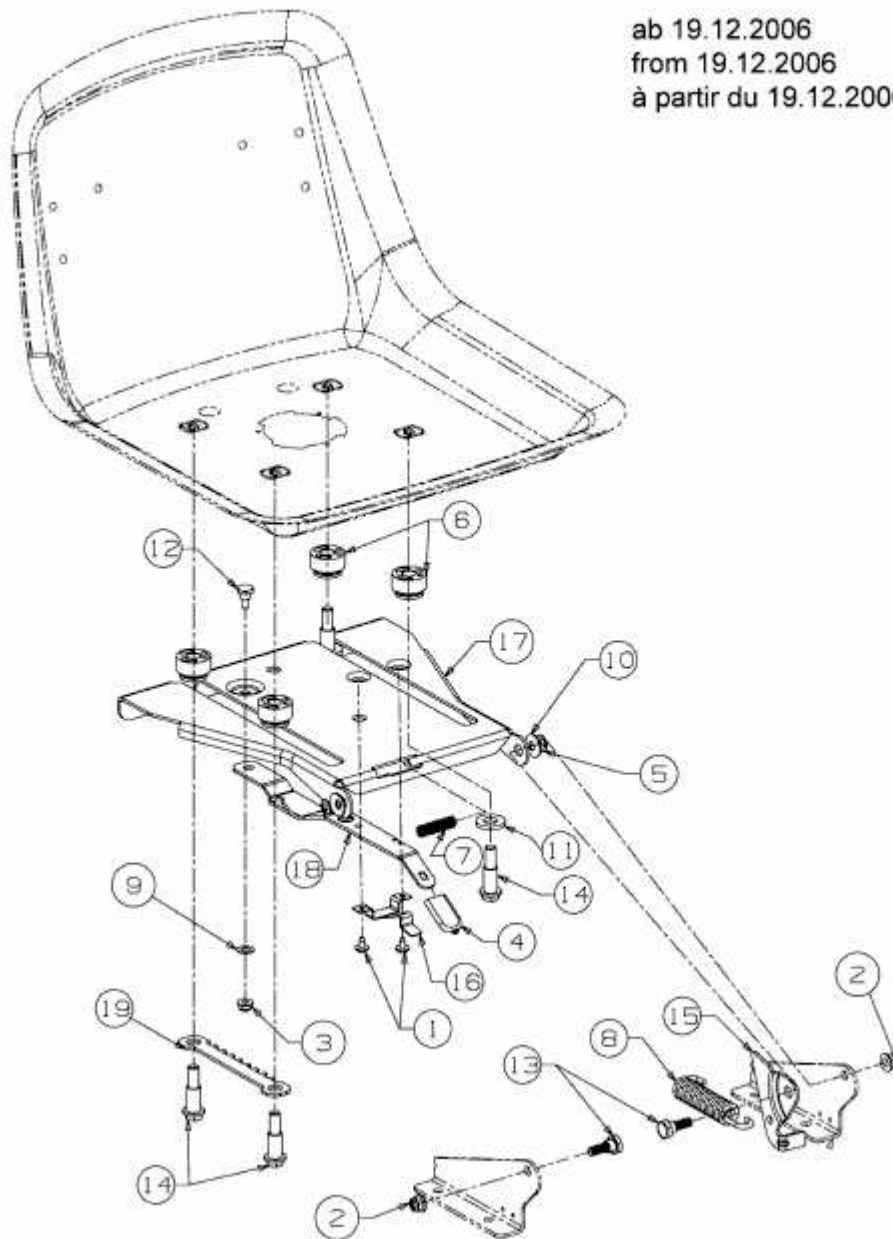

E3-02692A-03