

ab 15.01.2007
from 15.01.2007
à partir du 15.01.2007

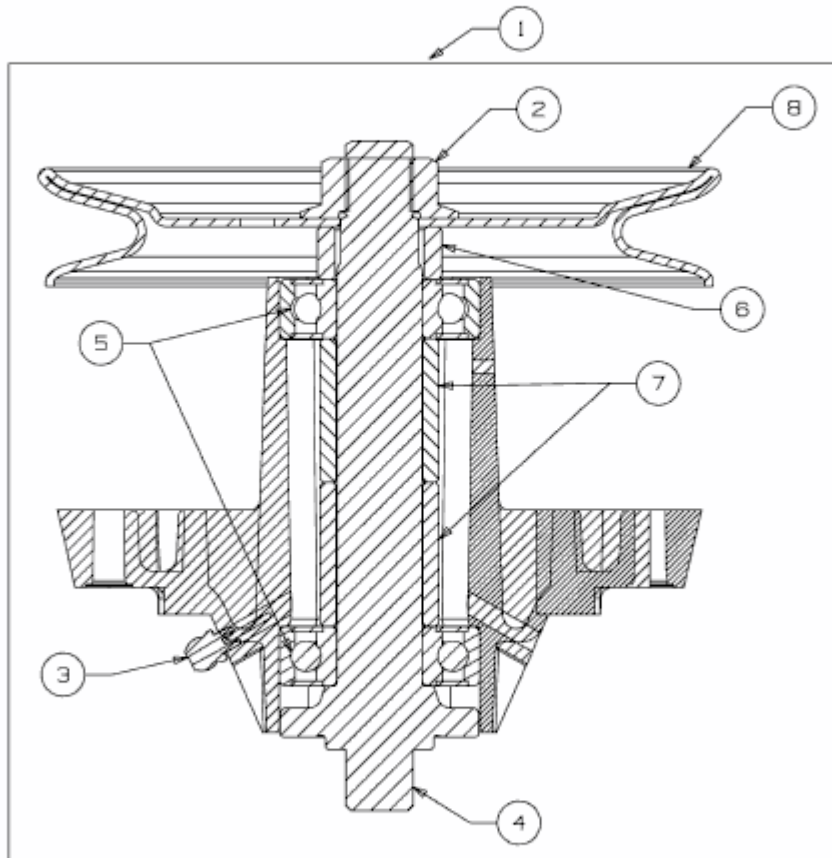

E3-04607A-02