

ab 17.11.2005
from 17.11.2005
à partir du 17.11.2005

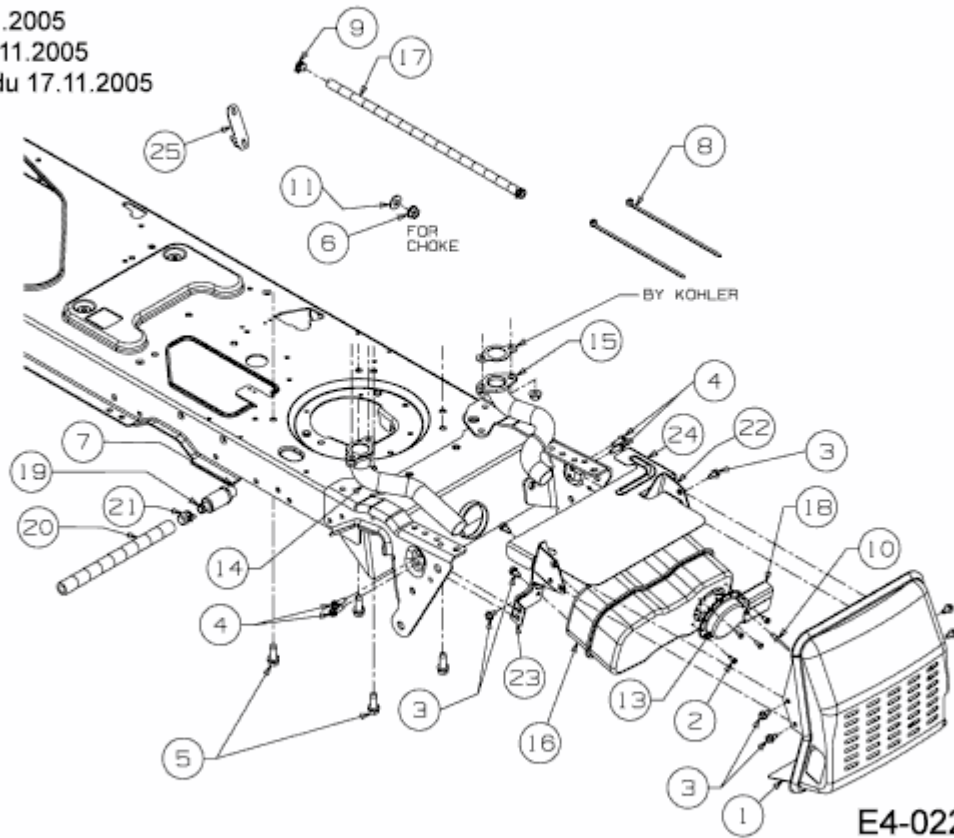

E4-02227A-01