

ab 01.11.2004
from 01.11.2004
à partir du 01.11.2004

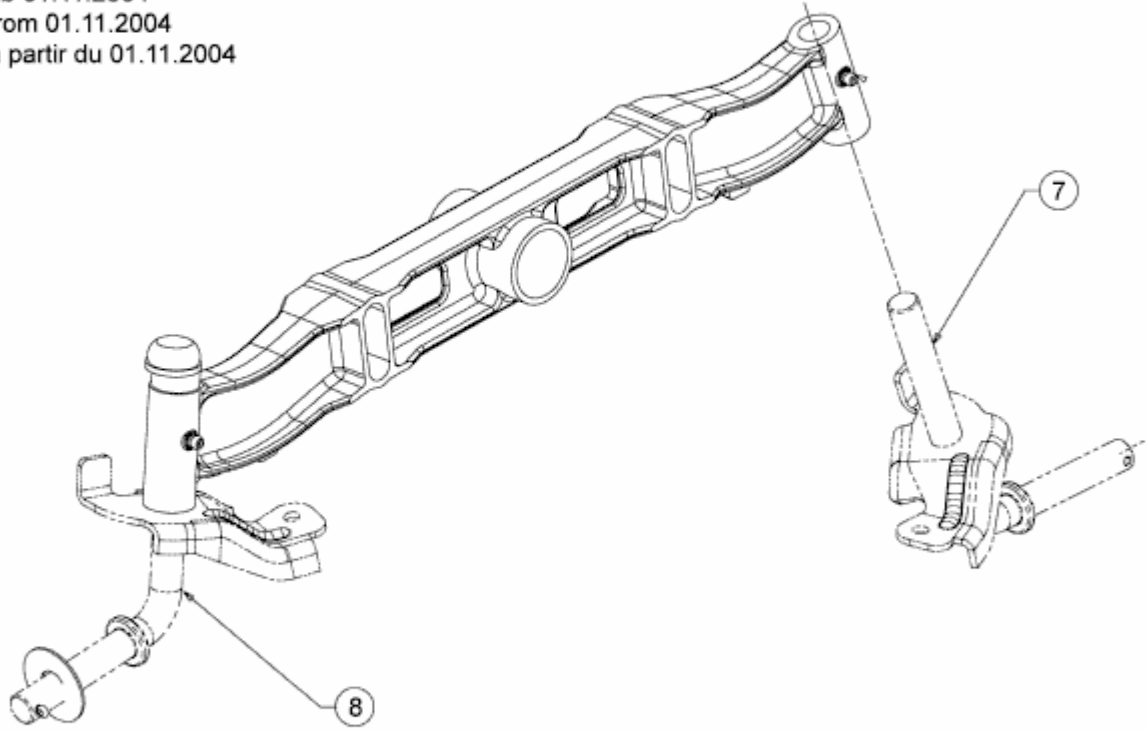

E4-02332A-02