

bis 31.10.2004
to 31.10.2004
jusqu'au 31.10.2004

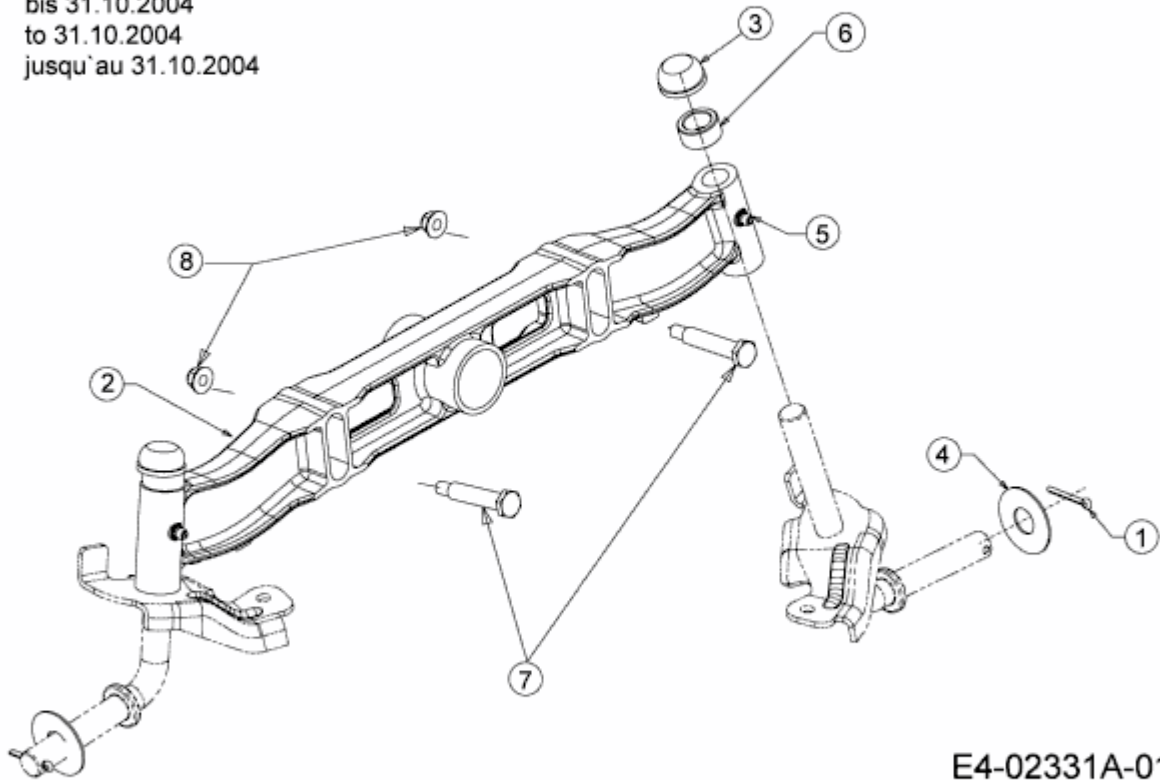

E4-02331A-01