

ab 09.12.2014  
from 09.12.2014  
à partir du 09.12.2014

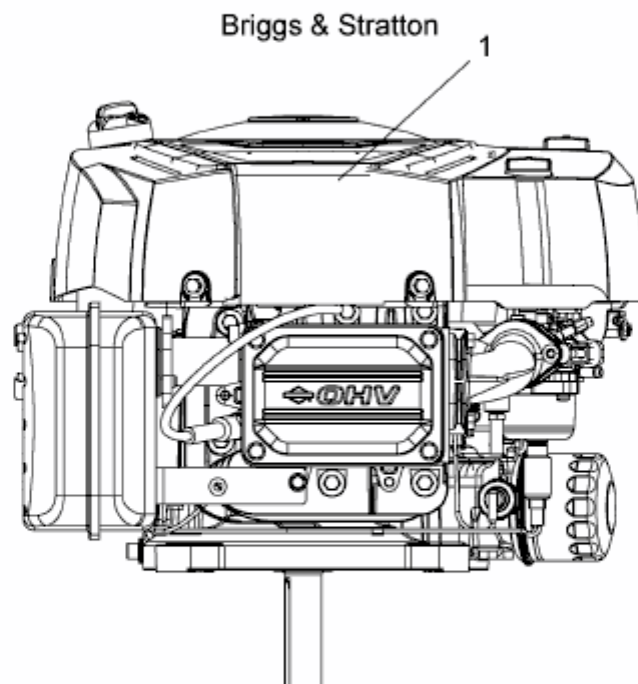

Model: 31R777  
Type: 0036B1

E3-09059A-02