

FORMULA 108/17 H > 13AD799G637 (2008) > ARMATURENBRETT

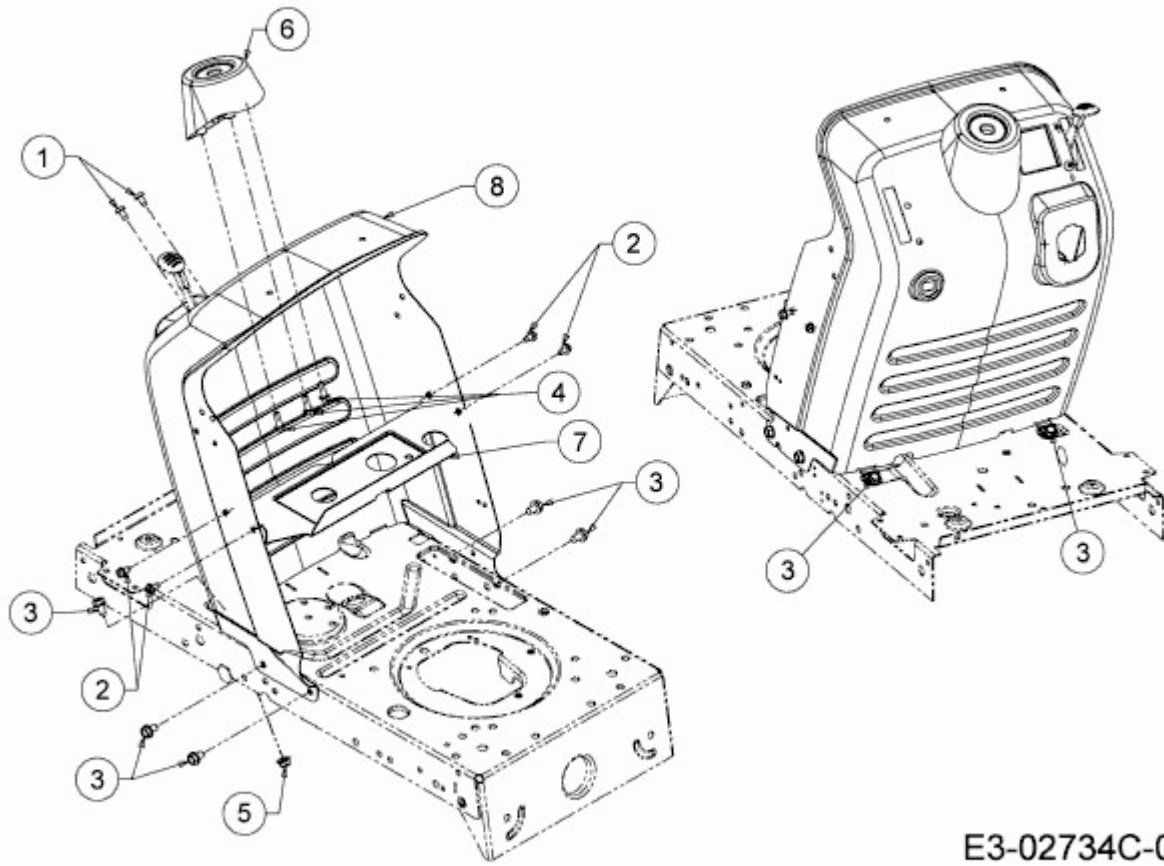

E3-02734C-01